

Futaba®*Flybarless Control Gyro***CGY750****INSTRUCTION MANUAL***V1.40~* **TABLE OF CONTENTS**

• Introduction	2
• Warranty and Repair Service (in U.S.A.)	2
• Features	2
• Contents	2
• Precautions	3
• Specifications	3
• Replacement and Optional Items	4
• Gyro Sensor Installation	4
• Connecting the CGY750	5
• Governor Installation	6
• Governor Fuselage Setting Precautions	6
• First Map	7
• Opening Screen	7
• Home Screen	7
• Warning Display	8
• Setting Menus	8
• S.BUS Basic Setting	9
• Swash Basic Setting	10
• Swash Servo Installation and Setup	13
• Aileron/Elevator Gyro Setup	13
• Flight Tuning Menu Definitions And Adjustment	14
• Tail Rotor Gyro Set Up and Rudder Basic Setting	15
• Rudder Gyro Basic Setting	15
• Governor Basic Setting	16
• Governor Speed Setting	18
• Recommended Gyro Gain Settings	18
• Before Flight Checklist	18
• Adjustments During the Test Flight	18
• Tuning Guidelines for CGY750	19
• Rudder Gyro Expert Setting	20
• Aileron and Elevator Gyro Expert Setting	22
• Swash Expert Setting	23
• Linkage Compensation	24
• Governor Expert Setting	25
• Tips for Using the CGY750 Governor with Electric Models	26

 : Instructions for gyro functions

 : Instructions for governor functions

Technical updates and additional programming examples can be found at:

www.futaba-rc.com/faq



INTRODUCTION

The Futaba® CGY750 is a combined 3-axis heading hold AVCS gyro and head speed governor in one box. Its cutting-edge MEMS (Micro Electro Mechanical System) sensor design, ultra high-speed processing speed and advanced PID control algorithm put it a quantum leap ahead of all other heading hold gyros in size, weight and performance. The CGY750 has been optimized to work for flybarless helicopters.

WARRANTY & REPAIR SERVICE (IN U.S.A.)

If any difficulties are encountered while setting up or operating your CGY750, please consult the instruction manual first. For further assistance you may also refer to your hobby dealer or contact the Futaba Service Center at the web site, fax or telephone number listed below:

www.futaba-rc.com or www.hobbyservices.com
 Fax (217)-398-7721, Tel (217) 398-0007

If you are unable to resolve the issue, pack the system in its original container with a note enclosed and a thorough, accurate description of the difficulty. Include the following in your note:

- Symptoms (including when the problem occurred)
- System (Transmitter, Receiver, Servos and model numbers)
- Model (Model name)
- Model numbers and quantity
- Your Name, Address and Telephone number

Send the respective items to the authorized Futaba Service Center Address below:

Futaba Service Center
 3002 N Apollo Drive Suite 1
 Champaign, IL 61822

FEATURES

- Combined 3-Axis Gyro and Governor in one box.
- High speed operation and extremely low latencies result in greater stability.
- Low profile, small size and light weight.
- Small size of the gyro and governor controller, 44 x 29 x 12mm, 13 g
- Utilizes a 128 x 36 dots graphical white color OLED (Organic Light Emitting Display), high brightness and contrast even in direct sunlight.
- Settings divided into Basic and Expert menus. The basic setting is for initial setting and Expert setting is for more advanced settings.
- Firmware can be updated from a Windows based personal computer when used with the optional CIU-2 interface.
- S.BUS compatible. Only one connection is necessary between the S.BUS receiver and CGY750 control box for operation.
- **Gyro section**
 - Advanced and adaptive PID control loop is utilized
 - Small and low profile 3-axis gyro sensor. 21 x 21 x 8.5mm, 8g
- **Rudder (yaw) section:**
 - Capable of sensing angular velocity up to +/- 1,200 deg/sec.
 - Compatible with 1520µS Analog (70Hz), 1520µS Digital (280Hz), and 760µS Digital (560Hz) tail rotor servos.
 - 3D and Sports flight mode
 - Feed Forward Option allows the CGY750 to consider other control functions during operation. This results in more accurate corrections and precise operation.
 - Cutting edge control algorithm provides a consistent pirouette rate, precise operation, and smooth yaw control in any flight condition.

Aileron, Elevator (roll, pitch) section:

- Developed specifically for flybarless helicopters.
- Included preset parameters for helicopter types (450-550, 600-700, and 750+) along with control feel preset parameters make initial setup as easy as pressing a button.
- Supports H3-120, H3-140, H3-90, H4-00, and H4-45 swashplate types.

Governor section

- Advanced and adaptive PID control loop is utilized.
- High speed operation and extremely low latencies provide a more consistent and accurate operation.
- Capable of governing head speeds from 700 RPM through 4000 RPM
- Compatible with 1520µS Analog (70Hz) and 1520µS Digital (280Hz) throttle servo types.
- Feed Forward Option allows the CGY750 to consider other control functions during operation. This results in precise governing of the head speed.
- Governor or Revolution Limiter mode selectable.
- Supports gear ratios from 1.00 through 50.00.
- Cutting edge control algorithm provides more consistent RPM governing.
- Revolution sensor is compatible with the GV-1. The CGY750 also supports an optional back plate revolution sensor and brushless phase sensor.

Other functions

- Maximum RPM memory.
- Cumulative engine operation timer.
- Power saving OLED.

CONTENTS

Your CGY750 includes the following components:

Type of set

- Gyro & Governor set w/R6303SB
- Gyro & Governor set
- Gyro set w/R6303SB
- Gyro set

SET CONTENTS				
CGY750 Control Amp				
*Mini Screwdriver	X	X	X	X
*Dust Covers (x3)				
Gyro Sensor				
*Mounting Pads (x3)	X	X	X	X
Revolution Sensor				
*Sensor Mounting Hardware	---	---	X	X
*Magnet (x2)				
R6303SB Receiver				
	---	X	---	X
Extension Cord	X	X	X	X

X: supplied ---: not supplied

CGY750 Control Box



Gyro Sensor



Mounting Pads



Revolution Sensor



Extension Cord



Dust Cover



Magnets (2)



Sensor Mounting Bracket



R6303SB Receiver



Adjustment Screwdriver



PRECAUTIONS

Meaning of Special Markings

Pay special attention to safety where indicated by the following marks:

⚠ DANGER - Procedures which may lead to dangerous conditions and cause death/serious injury if not carried out properly.

⚠ WARNING - Procedures which may lead to a dangerous condition or cause death or serious injury to the user if not carried out properly or procedures where the probability of superficial injury or physical damage is high.

⚠ CAUTION - Procedures where the possibility of serious injury to the user is small, but there is a danger of injury, or physical damage, if not carried out properly.

⊘ : Prohibited ① : Mandatory

⚠ WARNING

Failure to follow these safety precautions may result in severe injury to yourself and others.

• Read through the entire manual before operating this product.

BEFORE EACH FLIGHT:

① Always check the transmitter and receiver battery voltage to ensure they have enough remaining capacity to complete the flight.

① Always exit programming mode before attempting to fly the model.

① Only use the CGY750 with a 2.4GHz system such as the Futaba FASST™ system, or a PCM system. Use with an FM system is strongly discouraged since interference can cause serious operational problems.

Gyro operating precautions: Gyro

⊘ **The CGY750 requires 5-10 seconds to initialize when the power is turned on. Do not move the helicopter and do not move the tail rotor, aileron and elevator sticks during this initialization or the gyro may not initialize properly. Once the initialization process has been completed the swash servos and tail servo will move several times indicating that the CGY750 is now ready for flight.**

① Verify that the gyros are operating and compensating in the correct direction before each flight. If the compensation direction is incorrect on any axis the model will become uncontrollable after takeoff.

① Verify that the gyro is operating in the desired mode.

① Verify that the gyro mounting pads are in good condition.

① Verify that the gyro wires are not contacting the frame of the helicopter.

① The servo type parameters within the CGY750 must match the type of servo you are using. Incorrect setting may damage the CGY750 or the servos, possibly resulting in a loss of control during flight.

① Always ensure that there is some slack in the gyro cables to help maximize performance. Always use the supplied gyro mounting pads to attach the gyro to the helicopter mechanics. Do not use a strap that encompasses the CGY750 sensor. This may affect the overall performance of the gyro.

① Always allow the gyro to adjust to the surrounding environmental temperature before flight. A large temperature change during use will cause drift and other operational issues.

⊘ The gyro sensor and control box have an electroconductive coating. Do not allow any power leads or other wiring to come into contact with these items.

① If you are switching between Normal Mode and AVCS Mode in flight, please keep in mind that you must have the gyro re-learn the center position after making a trim change within the transmitter. To memorize the new center position simply flip the gain switch on the transmitter three times between Normal Mode and AVCS Mode (Normal→AVCS→Normal→AVCS) within one second. The servo will center indicating that the new center position has been memorized.

① When operating the gyro in AVCS Mode, all compensation and revolution mixing must be disabled and any tail rotor or swash offsets for flight modes must be disabled.

① When the CGY750 is operated in AVCS mode the tail rotor or swashplate servos will not center when tail rotor, aileron or rudder stick is released. This is normal operation for AVCS mode. The servos

may also move to the extent while the model is being carried out to the flight line. Before take off, you must visually center the tail rotor pitch slider and level the swash plate by using the transmitter control sticks. You can also center the servos by moving the tail rotor stick full left, then full right, back to full left and then allow the stick to center within one second; the same method applies for aileron and elevator servos.

⊘ Do not drop the CGY750 sensor onto a hard surface or subject the CGY750 sensor to a strong shock as this may damage the sensor.

① Always use the supplied mounting pads or the Futaba replacement mounting pads available from your local Futaba dealer.

Governor operating precautions: Governor

① When the throttle servo is connected to the CGY750, the battery fail-safe function within the CGY750 must be setup and enabled.

① Throttle fail safe function (transmitter setting): Use the fail safe function for the channel that turns the governor on and off to set the fail safe position to the point at which the governor is turned off. With this setting, when the system enters the fail safe state, the governor will be turned off, and the receiver throttle signal (fail safe position preset) will be output directly.

① When using the condition hold function on the transmitter, always set the throttle servo maximum operating point to less than the point at which the governor is activated. If this is not done the governor may activate while in condition hold.

① While preparing for flight or starting the engine, always ensure the throttle remains below the governor activation point and do not select any flight modes that may activate the governor.

① If you prefer to activate the governor while the model is still on the ground, always ensure that you have at least -5 degrees of pitch in the model before activating the governor. This negative pitch is necessary to prevent an unexpected lift off as the governor activates and the head speed increases to the desired RPM.

① Periodically check the RPM sensor output to ensure proper governor operation. Due to the high level of vibration and centrifugal forces the magnet may come loose or the sensor alignment may change. Every 10th flight verify that the magnet and sensor are properly mounted.

SPECIFICATIONS

Width (Controller): 1.14in [29mm]

(Gyro sensor): 0.83in [21mm]

(Revolution sensor): 0.30in [7.5mm]

Length (Controller): 1.73in [44mm]

(Gyro sensor): 0.83in [21mm]

(Revolution sensor): 0.63in [16mm]

Height (Controller): 0.47in [12mm]

(Gyro sensor): 0.33in [8.5mm]

(Revolution sensor): 0.39in [10mm]

Weight (Controller): 0.459oz [13g]

(Gyro sensor): 0.282oz [8g]

(Revolution sensor): 0.141oz [4g]

Operating Voltage: 3.8V to 8.4V DC*

Current Drain: 70mA

Selectable Servo Frame: 70Hz, 280Hz and 560Hz
(Rudder Gyro only) Rate

Center Pulse Width: 1520µs (70Hz & 280Hz)
760µs (560Hz)

Presets: 3D, Sports, 450-550,
600-700 and 750+

Governor Resolution: 0.1Hz (6rpm)
(Engine RPM)

RPM Accuracy: 1%

Head Speed Range: 700-4,000rpm

Operating Temperature: 14°F to 113°F
(-10°C to +45°C)

Control System: Digital advanced control

Sensor: Micro Electromechanical
Systems (MEMS) Gyro
Hall effect sensor

Angular Velocity Range: ±1,200 Degrees Per
Second (Gyro)

* The operating voltage shown only applies to the CGY750. Always verify that your receiver, servos, tail rotor servo, switch and any other electronic components used in your installation are capable of operating at the voltage you plan to use.

Futaba PC Interface CIU-2: **FUTM0951**

Extension 200 mm:
 Extension 350 mm:
 Extension 55 mm:
 Extension 80 mm:
 Extension 130 mm:

Mounting Pad:
 1x22x22 mm (10)

⚠ WARNING

❗ **Newer high end servos and other radio equipment are capable of placing large demands on the power systems in use today. When using a regulator you must ensure that the regulator is capable of supplying the current demands of the equipment you have selected. In addition to this make sure the wiring and switch you have selected are capable of handling high current draws.**

- The servo current draw can be up to 50% higher on a flybarless helicopter. Always ensure your receiver battery is fully charged before each flight.

❗ **Even though the CGY750 is a high performance gyro and governor, it will be necessary to ensure that the helicopter mechanics are also in optimum operating condition. Please use the guidelines below and address all issues before installing and flying the CGY750.**

- The CGY750 must be used with a rigid tail rotor drive system. Any modern torque tube or belt drive system should be adequate. Do not attempt to fly the CGY750 using a wire driven tail rotor system.
- Always ensure the drive gears, torque tube, pulleys, belt, bearings and shafts are in proper working condition. If any of these items are damaged or worn they must be replaced.
- The linkage rod, tail rotor bell crank, pitch slider and tail rotor grips must operate without friction to obtain the best performance from the CGY750. Binding in the tail rotor control linkage will decrease the performance of the CGY750 gyro and this may also shorten the servo lifespan. Please take the time now to ensure the tail rotor system on your helicopter is working correctly and without friction or binding.
- Vibration will affect the CGY750's overall performance. All rotating components on the helicopter should be balanced to minimize vibrations in flight. Ensure that your engine or electric motor is running smoothly and that all vibrations have been addressed before installing and test flying the CGY750.

Gyro sensor replacement:

- Each CGY750 gyro control box is calibrated specifically for the gyro sensor included. Do not attempt to use another CGY750 sensor with the control box as performance will suffer due to being out of calibration. The calibration process must be completed by an authorized service center.

If your sensor needs replacement, please send the complete unit to your region's support center for repair.

The gyro sensor should be mounted on a rigid platform, at least 6in [152mm] away from a Nitro Engine. It is not necessary to mount the gyro near the main shaft of the helicopter but it is very important that the mounting area chosen is rigid. Please refer to your helicopter manufacturer's instructions for recommended mounting locations.

Test fit the gyro sensor, ensuring that the sensor is in perfect alignment with the helicopter on the roll and pitch axis. The cable from the gyro sensor must exit toward the front or the rear of the helicopter since this is the pitch axis. Any misalignment will cause a loss of performance, so it is very important to ensure that everything is aligned properly.

Once you are certain everything is properly aligned and that the sensor lead can be routed to the gyro, go ahead and mount the gyro sensor to the helicopter using one of the supplied gyro pads. Route the gyro sensor lead to the CGY750 control box and plug the lead into the gyro sensor port. Verify that the connector is firmly locked in place.

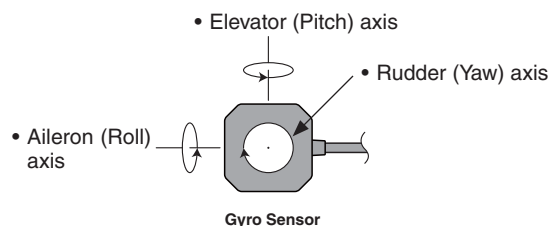

Important: The CGY750 gyro sensor must be mounted so that the roll and pitch sensing axis are in alignment with the helicopter. Any misalignments over 1/2 of a degree will cause a loss in performance. Please take extra care in this step to ensure the optimum flight performance.

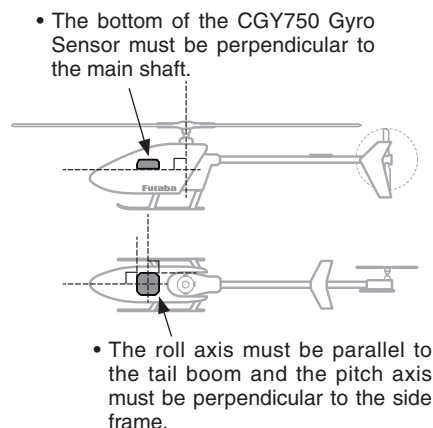

TROUBLESHOOTING

If any issues are noted during flight (such as drifting, inconsistent hold or inconsistent control rates) then please review the following troubleshooting recommendations.

1. Always verify that the tail rotor and swash plate mechanisms operate, and that the drive system is in proper working order.
2. Electromagnetic interference could be causing the problem. If you feel everything is set up correctly and that the helicopter is vibration free, then consider moving the gyro sensor to a new location away from servos, ESC and drive motors.
3. Vibrations will decrease the performance of all gyro systems. Even though the CGY750 gyro sensor is the most vibration resistant gyro sensor available, eliminating vibrations will always improve performance. Throughout extensive testing it has been found that the CGY750 gyro sensor performs best when the sensor is mounted rigidly to the airframe. This is mainly due to the sensing of all 3 axes. It is highly recommended to avoid using soft foam pads as this may allow the gyro to bounce around on the roll and pitch axis, causing instabilities and possible loss of control during flight.

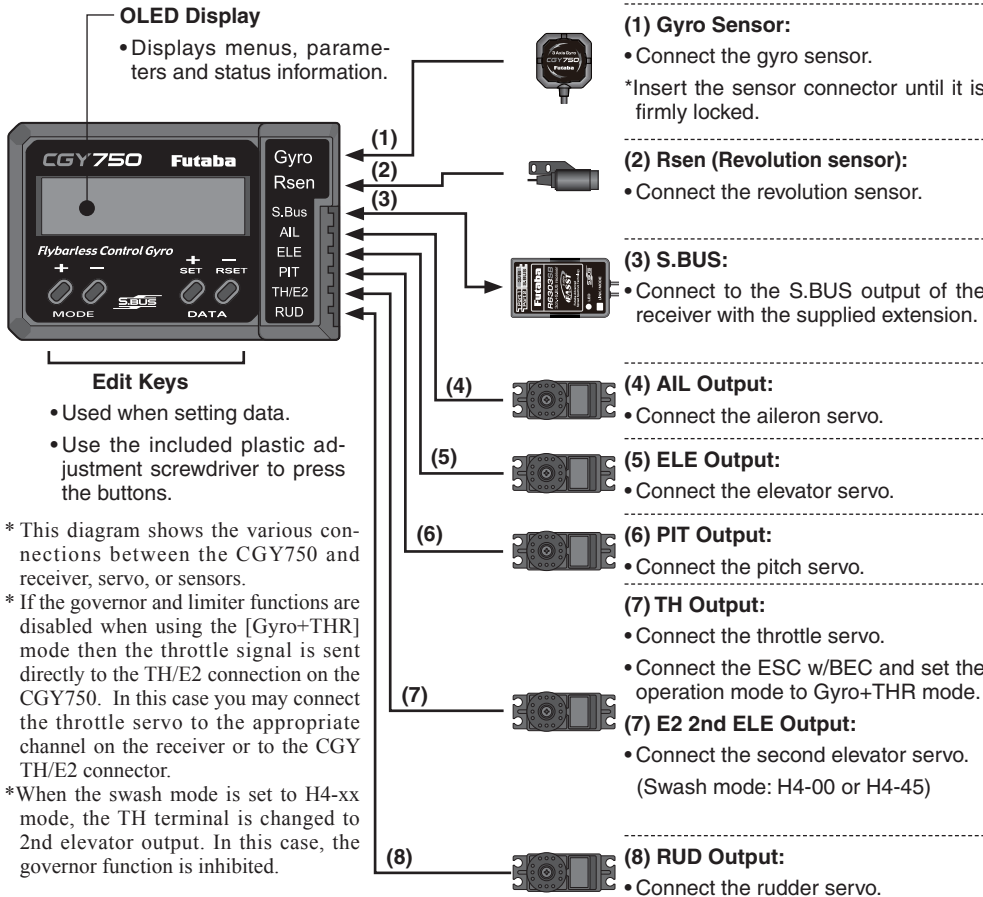

Installing the Sensor Connector

⚠ WARNING
❗ You will feel resistance at two points when inserting the connector. Make sure that you plug in the connector completely, or connection problems may result.

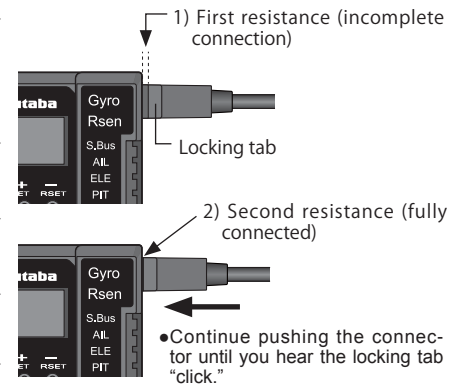

Connection to the receiver, servos and sensors

The CGY750 requires an S.BUS receiver or the optional PWM Receiver to S.BUS adapter available separately.

Using the supplied extension connect the S.BUS receiver port (or from the S.BUS PWM adapter) to the CGY750 S.BUS port. Install your receiver battery, regulator, switch and any other necessary electronics now. Connect the power lead of your switch / regulator to the battery connector on the receiver.

Plug the cyclic servos (AIL-[Aileron], ELE-[Elevator], PIT [Pitch], RUD [Tail Rotor] and if using the H4xx swash plate type TH/E2-[Elevator 2]) into the appropriate port on the CGY750.

Determine the best location to place the receiver and CGY750 control box. Mount the receiver and the CGY750 control box to the helicopter mechanics using vibration adsorbing self adhesive foam pads. The CGY750 gyro sensor will be installed in a later step.

Using wire mounts, wiring fixtures molded into the helicopter, or hook and loop material, route the servo leads and extensions. Make sure the wires are not rubbing against metal or carbon fiber which may damage the wires.

S.BUS channel setting

Since the S.BUS protocol uses a single wire to transmit all channel information to the CGY750 it is necessary to assign each channel number (1 through 16) a function (such as aileron, pitch, collective, gain, ail gain, ele gain, rpm, gv on/off) within the CGY750 control box. The default CGY750 S.BUS channel assignments should work properly with most Futaba transmitters. If you experience any problems please refer to the S.BUS section of the manual to set/verify each channel number for each function.

❑ If your transmitter does not offer enough channels to operate all of the CGY750's functions, it is possible to operate the CGY750 without the GV On/Off, Ail Gain, and Ele Gain channels connected. When any these functions are not used, it is necessary to set the channel number to [INH] within the CGY750's S.BUS menu to disable the function and to use the setting value inside the CGY750 menu instead.

When the GV On/Off channel is not used, the governor on/off control is handled by the [Stick Switch] function.

When the remote Ail or Ele Gain channels are not used, the operating mode (NOR/AVCS) and gain value can be set in the appropriate AIL / ELE Basic menu option by using the Data +/- keys when the function is displayed.

Using the CGY750 with a electric helicopter

⚠ DANGER
❗ It is necessary to remove the pinion gear from the electric motor or disconnect the motor from the ESC before powering the model up for setup or bench testing. Electric motors are extremely powerful and capable of delivering the power instantly, causing injury to yourself, others, or the surroundings.

If the CGY750 is being installed into an electric helicopter and the ESC's own internal governor is to be used, you may want to consider connecting the ESC to the [TH/E2] (throttle / elevator 2) output of the CGY750. Before doing this you must remove the pinion gear from the electric motor or disconnect the motor from the ESC before powering the model up the first time. Once the model has been powered up, navigate to the gyro mode function and set it to [GYRO+THR]. This sets the CGY750 to act as a gyro and throttle output. The CGY750 will simply pass the throttle signal from the receiver through to the TH/E2 port on the CGY750.

Once your ESC is connected to the CGY750, you must complete all necessary transmitter setup (ATV / EPA / REV / ETC) per your ESC instructions. Please refer to the end of this manual for further suggestions for the use of the CGY750's governor with electric powered models.

GOVERNOR INSTALLATION

Modify the cooling fan and install the accessory magnet and attach the magnetic sensor to the engine at the position shown below. Balance the cooling fan as needed following magnet installation.

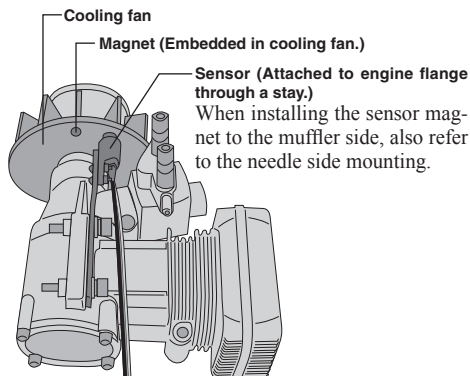

Magnet operating side check

- ❑ Bring the magnet near the end of the sensor and check the operating side.

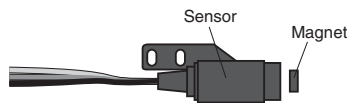

This is the side at which the displayed value increases in the “Revolution sensor testing” menu within the “**Governor Basic Setting**” section earlier in this manual. Install the magnet with this side facing the sensor. Mark this side of the magnet with a felt tip pen.

Cooling fan modification

- ❑ Drill a hole in the fan at the magnet mounting position. Make the hole about 4.1mm in diameter and 1.5 to 1.7mm deep.
- ❑ Embed the magnet in this hole in the direction in which an output is obtained. Use epoxy adhesive that cures in 30 minutes or longer. Do not use epoxies that contain metal such as JB Weld.

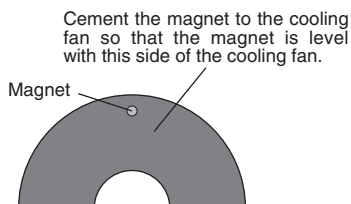

- ❑ If the cooling fan is unbalanced and vibrates, etc., balance it by mounting the spare magnet to the opposite side of the cooling fan in the opposite polarity (so that it does not output a signal).

Sensor mounting

The sensor mounting method depends on the helicopter and engine.

- ❑ Mount the sensor to the sensor stay. (Temporary assembly)
- ❑ Drill a hole in the fan cover at the part corresponding to the sensor so that the distance between the sensor and magnet can be made 1 to 2mm.
- ❑ Tighten the sensor stay together with the engine mounting flange. (Temporary assembly)
- ❑ Select the mounting method so that the sensor does not touch the frame, or other parts of the helicopter. Temporarily mount the sensor and select the magnet mounting position.
- ❑ Install the sensor to the sensor stay using the accessory screws and washers.
- ❑ Tighten the sensor stay together with the engine using the engine mount screw.



Sensor adjustment

- ❑ Adjust the sensor position to obtain a sensor output of at least 60% in the “Revolution sensor testing” menu within the “**Governor Basic Setting**” section earlier in this manual.

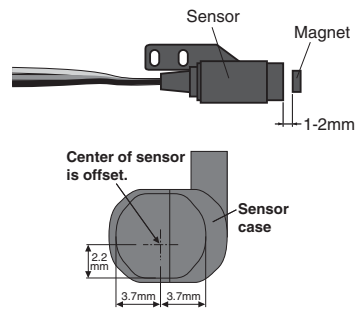

- ❑ The center of the sensor is different from the center of the sensor case so be careful when mounting the sensor.

If the display is less than 60% when the magnet is directly below the sensor, bring the sensor closer to the magnet so that the 60% or more is displayed. The magnet and sensor gap criteria is approximately 1 to 2mm. If a sensor output is not obtained even when the sensor is brought close to the magnet, the magnet and sensor center positions may have changed.

- ❑ Complete assembly of the sensor by securely tightening the screws that were temporarily tightened.
- ❑ Recheck the sensor output.

GOVERNOR FUSELAGE SETTING PRECAUTIONS

Throttle servo linkage precautions

To effectively use the governor, observe the following precautions when connecting the servo linkage.

- ❑ Make the servo operating range as wide as possible. Make the throw of the transmitter EPA (ATV) function and AFR function as close as possible to 100%.
- ❑ Fly with the governor turned OFF and adjust the needle so that the engine smoothly reacts to movement of the transmitter stick.
If there is a point at which the reaction of the engine is considerably different due to a too rich or too lean mixture, the governor may not operate to its maximum potential.

Fuselage vibration countermeasures

If the helicopter frame is weak, or the engine mount is deformed or not installed properly, the vibrations applied by the engine will increase. Engine vibrations will lead to unstable speed and prevent the governor from providing maximum performance. Therefore, make sure that the engine is vibration free and that the carburetor provides linear throttle control because the governor cannot correct engine problems.

Use of a tuned silencer

The use of a tuned pipe type silencer may cause the engine throttle response to be substantially different from that of a normal muffler. Adjust the needle (and pipe length) so that engine speed changes are proportional to the throttle opening. The governor will not perform satisfactorily with a muffler or a pipe that does not allow the carburetion to be linear.

FIRST MAP

Home screen

The figure shows the first layer of the editing sequence.

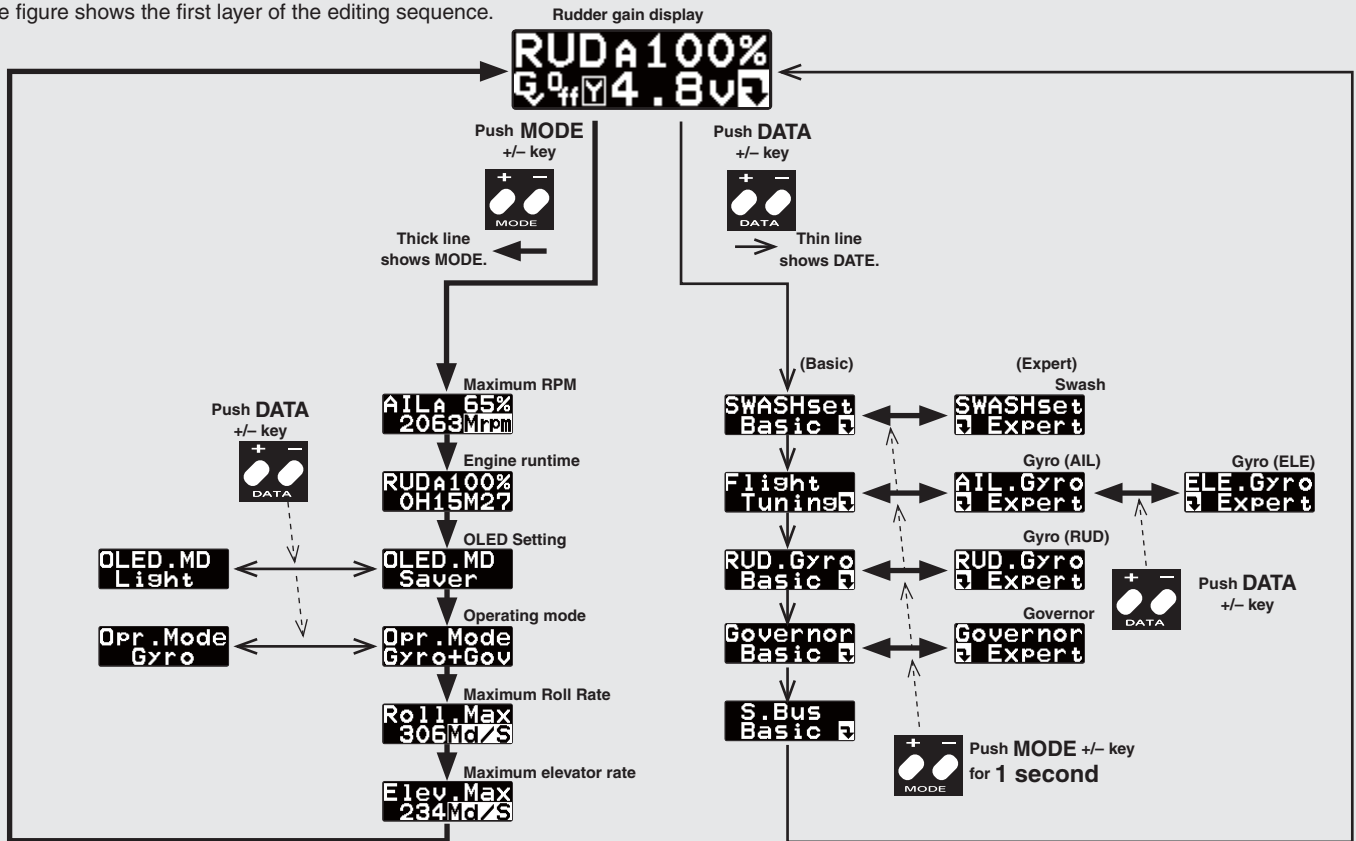

OPENING SCREEN

Verify that all of the connections are correct between the CGY750, receiver, and power supply. If your helicopter is using an electric motor for propulsion, remove the pinion gear now for safety.

If this is the first time the helicopter has been powered up, remove the servo arms and linkages to prevent damaging the servos if any binding is present. Power up the transmitter and allow it to initialize. Turn the receiver on or connect the flight battery and allow the helicopter to remain motionless while the CGY750 initializes.

The display will first show the ID number of your CGY750 and the Firmware Version.

ID 10000
Ver:1.40

After the CGY750 has powered up the screen will change to show an animation of a helicopter performing a stationary flip. This indicates that the initialization process is taking place. The helicopter must remain perfectly still so the controller can determine the gyro's center position for each axis.



Once the initialization process has been completed the Home Screen will be displayed and the cyclic + tail rotor servos will move several times in quick succession.

If the CGY750 is set to the [Gyro+THR] mode or if the H4-xx swash plate type has been selected then the governor will be disabled and the screen will look like (d) below instead. The display will cycle through and show the current AIL, ELE and RUD gains.

Home SCREEN

Initial Home screen

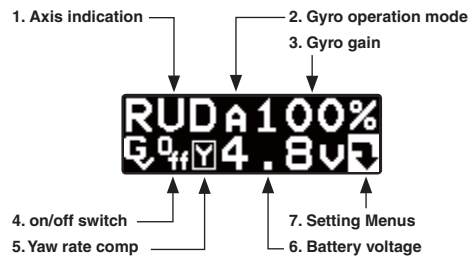

1. Axis indicator Gyro

The axis indicator will cycle every two seconds and show the axis (AIL, ELE or RUD) and their respective current gain values.

2. Gyro operation mode Gyro

The display indicates either [A] for AVCS or [N] for Normal operating modes. If the [A] is shown in inverted colors then the rudder neutral is offset and re-learning the center position should be completed immediately.



When using the AVCS operating mode, the servos will not re-center when the control stick is released. If you need to center the servo, you can move the appropriate control stick to its full extent (left & right or up & down) twice and allow the control stick to return to center within a one second period of time, and the servo(s) for that axis will return to center position.

For example if you move the tail rotor stick full left, full right, full left, full right and allow it to come back to center within one second, then the display will change to show [-----], and the tail rotor servo will center.

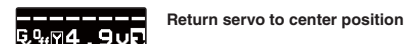

When using the AVCS operating mode and if trim changes have been made on any axis, then the neutral position must be read and memorized by the CGY750. To do this simply change the operating mode twice within one second (for example Normal → AVCS → Normal → AVCS) and the display will change to [*****] to indicate that the current stick position has been memorized as the new neutral position.

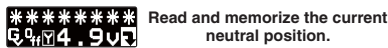

3. Gyro gain Gyro

This indicates the current gyro gain for the axis noted in the Axis Indicator position.

4. Operating condition Governor

This indicates whether the governor is [ON] or [OFF].



5. Yaw rate comp. Governor

This indicates that the Governor yaw feed forward function is enabled.

6. Battery voltage

This indicates the battery voltage. The display will change to show [LOW BAT] once the voltage has fallen below the Battery fail safe voltage setting (BFS).

7. Setting Menus

Pushing this button will exit the normal operating mode and enter the settings menu mode.



RPM display Governor

The battery voltage display automatically changes to the engine RPM display once the engine is running and returns to battery voltage display once the engine has stopped running. The RPM display can be either the head speed or the engine speed depending on the setting in the revolution display mode setting found in the governor Expert menu.

Home screen options

When the home screen is shown the mode [+] and [-] keys can be used to cycle the bottom line through the following items; Battery voltage, Max RPM, Engine runtime, OLED display options, Operating Mode, Roll rate maximum display, and Elevator rate maximum display.

1. Maximum RPM Governor



From the home screen press the mode [+] button once to show maximum recorded RPM [Mrpm]. The [Mrpm] value is maintained until you clear it by pressing the data [+] or [-] key for at least one second. This function allows you to check for over speeding during flight.

2. Engine runtime Governor



From the home screen press the mode [+] key twice to show the engine runtime display. The time shown is how long the engine has been running. This is a cumulative timer and the value is maintained in memory. To reset the timer simply press the data [+] or [-] key for more than one second and the timer will reset back to 0.

3. OLED display options [default: Saver]



When the [Saver] option is selected, the display will dim after 60 seconds of inactivity. Once a button is pressed on the CGY750 controller box, the OLED will switch back to full brightness. The [Saver] option helps to conserve power and extend the life of the display. When the [Light] option is selected the display will remain at full brightness at all times.

4. Operation mode [default: Gyro+Gov]



This selects the operating mode of the CGY750.

⚠ WARNING

❗ If the operating mode has been changed, then the CGY750 must be reset by powering down and then powering back up.

[Gyro+Gov] Both the gyros and the governor are operational.

[Gyro+THR] The gyro is operational, and the governor is disabled. The throttle channel from the receiver is passed through to the [TH/E2] port on the CGY750.

[Gyro+H4] Must be selected when a [H4 xx] swash plate type is selected. This disables the governor and throttle servo output and the [TH/E2] port on the CGY750 is now the second "Elevator" [E2] servo output.

5. Roll rate maximum display Gyro



This screen displays the maximum roll rate recorded during flight. This value is reset back to 0 when the CGY750 is powered up.

6. Elevator rate maximum display Gyro



This screen displays the maximum elevator rate recorded during flight. This value is reset back to 0 when the CGY750 is powered up.

WARNING DISPLAY

Governor warning display Governor



The warning symbol is displayed when the governor is activated during power up. Immediately switch to a condition that has the governor disabled, and the symbol will disappear. When this warning symbol is shown, the governor will be disabled until the flight condition has been turned off. The engine must be started with the governor turned off.

Sensor Error Gyro



⚠ WARNING

❗ The helicopter must remain motionless during the initialization process or a [SensorER] sensor calibration error may occur.

If a sensor error occurs during initialization, the sensor itself may be defective.

Please contact your region's technical support center (the contact information can be found in the beginning of this manual).

Low battery



⚠ WARNING

❗ The [Low Batt] warning is displayed if the receiver battery voltage falls below the [BAT/FS] voltage set within the CGY750 Governor Expert menu. If this condition lasts for more than one second, then the Battery Fail Safe function activates, and the throttle servo is brought back to idle position. This is done to warn you that the battery voltage is dangerously low and that you must land immediately.

The throttle operation can be temporarily reactivated by bringing the transmitter control stick all the way back to idle; normal throttle function will return. After 30 seconds the Battery Fail Safe function will activate again requiring you to repeat this process if necessary. The model should be landed as soon as possible.

Memory writing indicator



⚠ WARNING

⚠ Do not power off the CGY750 when the Memory writing symbol is displayed.

When a setting is changed within the CGY750 the new value must be written to memory. The "Memory writing indicator" is displayed during this process. This process may take up to two seconds, and the power must not be switched off during this time.

If the power is switched off during the writing process, then all of the settings may be lost.

SETTING MENUS

⚠ WARNING

❗ Always exit the Setting Menu and return to the home screen before flying your model. The gyro operation is disabled within several of the settings menus to ease set up.

❗ Always check the operation of the CGY750, verify that the controls are operating the correct direction and ensure the gyros are correcting in the proper direction for all axes prior to attempting to fly the model.

The data [+] and [-] keys are used to navigate through the Setting Menus: [RUD.Gyro], [AIL.Gyro], [ELE.Gyro], [SWASHset], [Governor]* and [S.BUS] Basic menus. Once the desired menu is shown press and release the mode [+] or [-] key to show the next or setting items respectively.

The expert menus are entered or exited by pressing and holding the mode [+] or [-] key for one second. To exit the current menu simply go back to the Basic Settings Menu for the function (for example, [AIL.Gyro - Basic]) and press and release the mode [+] or [-] key until the home screen is shown.

Please see the Setting Menus diagram for a complete listing of the Home Screen, Basic and Expert menus.

*The [Governor] setting menu is not displayed if the Operating Mode has been set to [Gyro+Thr] or if the swash plate type has been set to the H4 xx type.

Since S.BUS sends all 18 channels (may be limited by your transmitter) over a single wire, it is necessary to assign a CGY750 function (such as AIL, ELE or PIT) to each channel. The channel assignments are performed within the [S.BUS].Basic menu.

If a function is not going to be used, then it must be set to [INH]. For example, if the AGN and EGN remote gain functions are not going to be used, then set them to [INH] and the CGY750 will then allow you to make gain adjustments within the respective menu.

S.BUS BASIC MAP

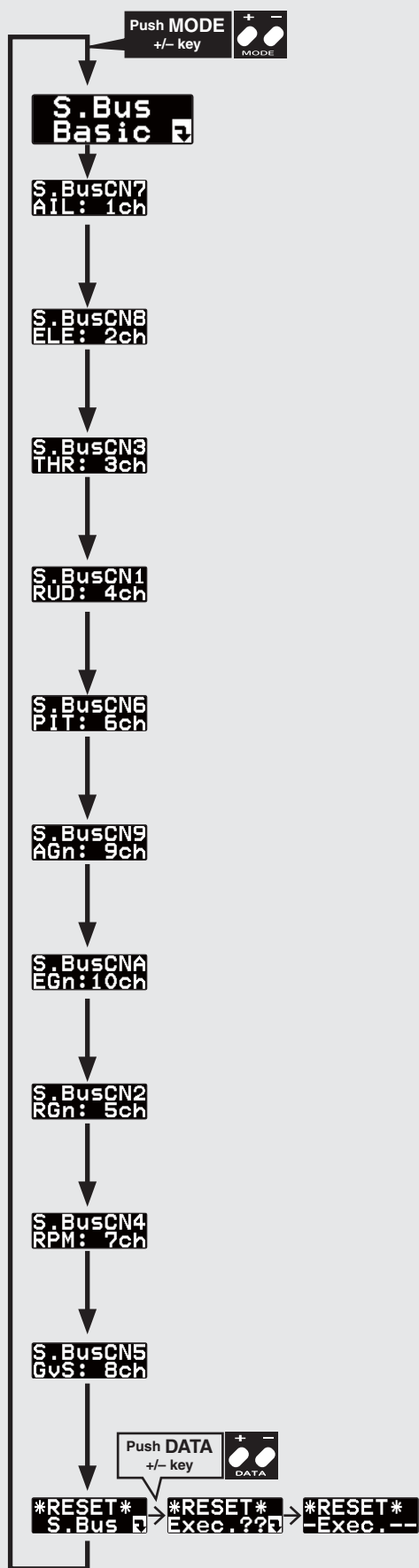

(1) S.BUS connection setting: start display

Use the mode [+] or [-] keys to navigate through the menu.

Setting ranges common: 1 ~ 16ch, DG1, DG2, INH

⚠ WARNING

Always verify that the S.BUS function assignments match your transmitter's function (in the FUNCTION menu) assignments. If any changes are made within the transmitter function assignments, then it will also be necessary to make the changes within the S.BUS function assignments.

(2) S.BUS setting: Aileron channel [default: 1ch]

Using the data [+] or [-] keys to set the correct channel number.

(3) S.BUS setting: Elevator channel [default: 2ch]

Using the data [+] or [-] keys to set the correct channel number.

(4) S.BUS setting: Throttle channel [default: 3ch]

Using the data [+] or [-] keys to set the correct channel number.

(5) S.BUS setting: Rudder channel [default: 4ch]

Using the data [+] or [-] keys to set the correct channel number.

(6) S.BUS setting: Pitch channel [default: 6ch]

Using the data [+] or [-] keys to set the correct channel number.

(7) S.BUS setting: AIL gain channel [default: 9ch]

Using the data [+] or [-] keys to set the correct channel number.

(8) S.BUS setting: ELE gain channel [default: 10ch]

Using the data [+] or [-] keys to set the correct channel number.

(9) S.BUS setting: RUD gain channel [default: 5ch]

Using the data [+] or [-] keys to set the correct channel number.

(10) S.BUS setting: RPM channel [default: 7ch]

Using the data [+] or [-] keys to set the correct channel number.

(11) S.BUS setting: GOV. on/off channel [default: 8ch]

Using the data [+] or [-] keys to set the correct channel number.

(12) S.BUS data reset

This resets the S.BUS channel assignments back to the defaults. Press the data [+] key and [Exec.??] will be displayed as a confirmation. Press data [+] to confirm the reset back to the default settings.

The [SWASHset] → Basic menu contains all of the functions necessary to set up the swash plate servos and to set up all swash plate mixing functions.

SWASH BASIC MAP. 1/3

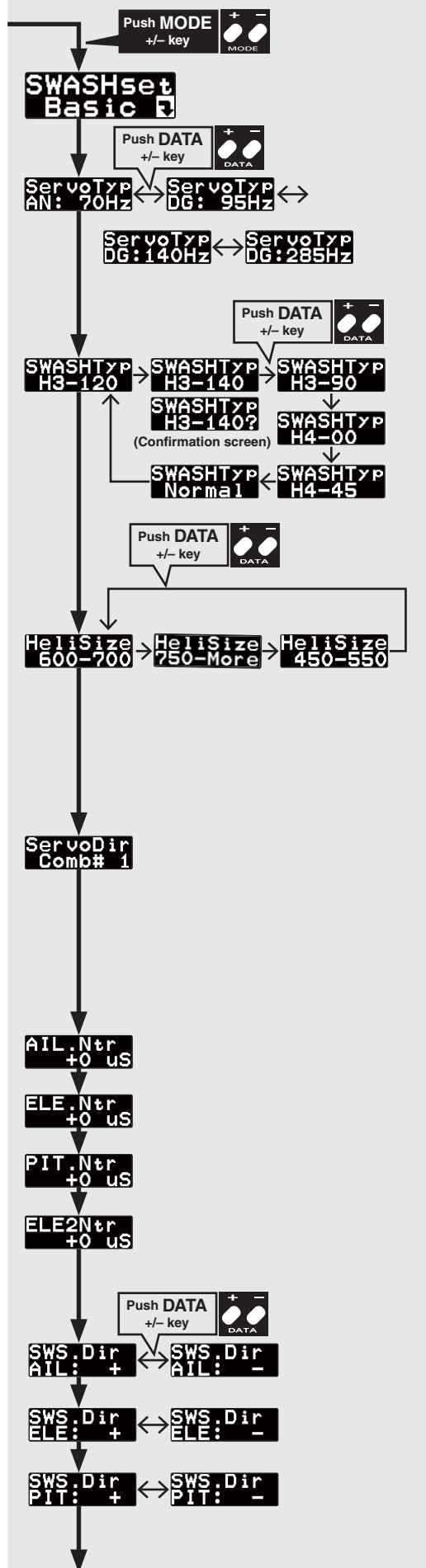

(1) Start display

The editing menus are scrolled by pushing the MODE+ or - key

(2) Servo type [default: AN(Analog):70Hz]

This selects the swash servo types. There are four kinds of the servo driving frequency selection, AN:70Hz, DG:95Hz, DG:140Hz, DG:285Hz. Previous version supported Analog= AN: 70Hz and DG:1520= DG:285Hz only. All Futaba digital servos can be worked with fastest DG:285Hz mode but some of other brands servos do not support DG:285Hz mode. In this case, select the proper servo driving frequency to meet the servos.

⚠ WARNING

Read your servo instruction sheet to determine the proper servo settings. The servo type parameter within the CGY750 must match the type of servo you are using. Incorrect setting may damage the CGY750 or the servo. Incorrect setting may also result in a loss of control during flight.

(3) Swash type [default: H3-120]

Select the swash plate type. Pushing the DATA+ or - key, display shows the confirmation screen as xxx?. Pushing the SET key, the type is changed. Pushing the RSET key or no operation the key for more than 1 second, the display returns to previous setting. When the type is changed, all swash parameter are reset.

⚠ WARNING

All of the swashplate parameters are reset when the swash plate type is changed. Please proceed through the entire setup process before attempting to fly the model.

(4) Helicopter Presets [default: 600-700]

This selects the heli size by 3 different categories. Preset the recommended parameter when it is selected. Select the type by the main rotor diameter. The type is changed by pushing data+ or - key.

(5) Swash servo direction setting [default: 1]

This parameter facilitates achieving proper swash servo movement electronic CCPM models (eCCPM) In the H3-xx swash mode, three of the swash servos directions are changed by pushing the DATA[+] or DATA[-] key. Choose the combination number which produces level swashplate travel with a collective pitch input from the transmitter. There are 8 combination choices for the H3-xx swash mode. On H4-xx swash mode, there are 16 combination choices. After selecting the combination number, aileron, elevator, pitch, and 2nd elevator servo parameters are automatically set.

NOTE: Occasionally the aileron or elevator function directions are reversed even though collective pitch direction is correct. In this case, change the direction of the affected function using the SWS.Dir parameter. The sign of its value will change from (+) to (-) or vice versa.

(6) Servo neutral adjustment [default: 0µS ranges: -116~0~+116µS]

This menu is effectively a subtrim or individual neutral adjustment for each of the swash plate servos. All servo arms should first be positioned as perpendicularly as possible to the control linkage with the collective stick positioned at 0 degrees collective (usually centered at half stick). Only then and if needed should neutral adjustments be made with goal being to keep them as small as possible. The ELE2 neutral adjustment only works if the H4-xx swash plate type has been selected.

To use this function select the servo you would like to adjust and press the DATA [+] or [-] key to position the servo as desired.

(7) Swash direction setting [default: +]

This selects the aileron, elevator and corrective pitch direction. Reverse the direction when the stick movement and swash movement are opposite.

SWASH BASIC MAP. 2/3

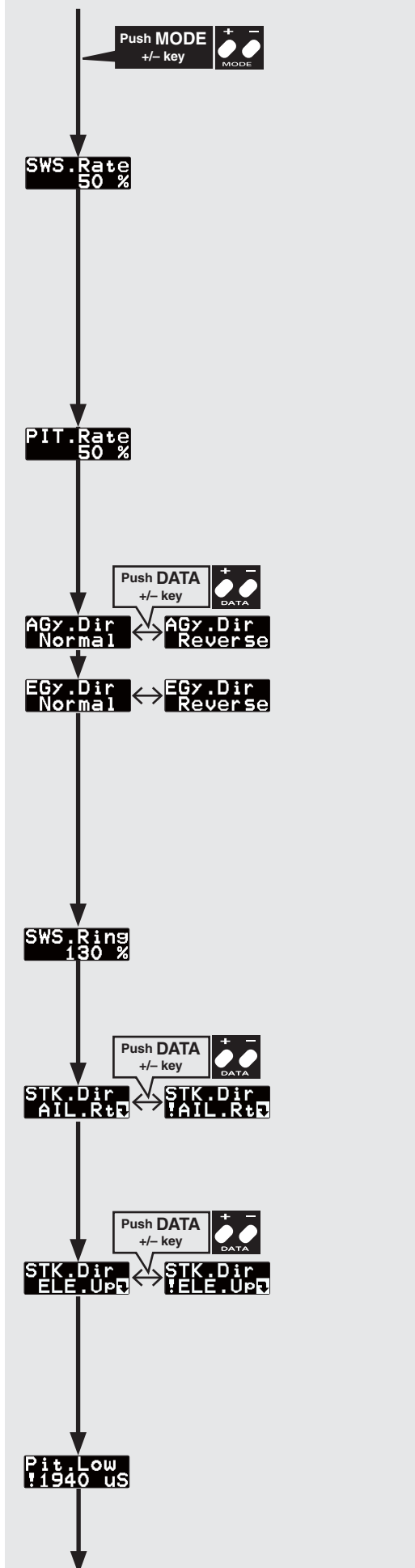

(8) Swash AFR (rate adjustment) [default: 50% ranges: 0~100%]

The Swash AFR settings are used to adjust the amount of throw allowed for roll (aileron) and pitch (elevator). The one setting applies to both roll and pitch axes; they are not individually adjusted. Use the Data [+] or [-] key to make an adjustment.

The [SWS.Rate] is dependent on servo arm length and head geometry, so it will be necessary to use a pitch gauge to make adjustments. For the cyclic controls it is recommended to start with at least 9-10 degrees of pitch change in any one direction (e.g. UP or DOWN or LEFT or RIGHT cyclic input). Adjustments to this value can be made after the first test flight once you observe the cyclic rates in flight and the overall gyro behavior.

NOTE: When NORMAL swashplate mode is chosen, the SWASH AFR menu is visible but inactive. Adjust cyclic and collective pitch mechanically to the same suggested ranges via servo arm size and with transmitter AFR/DR 's set at 100%. When measuring the cyclic pitch range, place the AIL and ELE gyros in NORMAL/Rate mode and set AIL and ELE gyro gains temporarily to 0%.

(9) Pitch AFR (rate adjustment) [default: 50% ranges: 0~100%]

The [PIT.Rate] is the amount of collective pitch travel allowed, and this value will be similar to what you may have traditionally used with a flybarred helicopter. A good starting range for Sport, 3D and F3C is +/-10 to +/-12 degrees. Beginners may want to change the negative collective pitch value to -3 degrees instead of -10. Use the Data [+] or [-] key to make an adjustment. 50% ranges: 0~100%

(10) Aileron (roll)/ Elevator (Pitch) Gyro direction setting [default: Normal]

This parameter controls which direction the CGY750 (roll / pitch axis) will compensate when the helicopter rolls (pitches). Pick the helicopter up and roll the helicopter to the right. The CGY750 should compensate by adding left cyclic to the swash plate. (Pick the helicopter up and rotate the nose of the helicopter downward. The CGY750 should compensate by adding aft cyclic to the swash plate.) If the CGY750 compensates in the wrong direction, then it will be necessary to reverse the Compensation Direction setting by pressing the [+] or [-] data key once.

⚠ WARNING

❗ Verify that the CGY750 compensates in the correct direction before flight. If the compensation direction is incorrect the model will roll and/or pitch uncontrollably at lift off.

(11) Swash ring [default: 130%]

This function is used to prevent binding of the swash plate servos when the transmitter control stick is moved toward a corner (for example, full right and full aft cyclic). Press the Data [+] or [-] key to adjust the value.

(12) Aileron direction memorizing

This function teaches the direction of aileron swashplate movement to the CGY750. Move the aileron stick to RIGHT full and push the DATA [+] or [-] key. The RIGHT direction of the aileron data will be saved to CGY750. To confirm the setting, move the aileron stick to full RIGHT, and the "!" mark will appear on the display. This procedure must be done for the F/F mixing to function correctly.

(13) Elevator direction memorizing

This function teaches the direction of elevator swashplate movement to the CGY750. Move the elevator stick to full UP and push the DATA [+] or [-] key. The UP direction of the elevator data will be saved to CGY750. For clarification purposes, UP refers to the direction the ELE stick would be pulled to raise the nose of an upright model in flight and which would yield an aft swashplate deflection. To confirm the setting, move the elevator stick to full UP, and the "!" mark will appear on the display. This procedure must be done for the F/F mixing to function correctly.

(14) Pitch low memorizing [default: 1940µS]

This parameter saves the minimum collective pitch point into the CGY750. Move the collective pitch stick to minimum pitch and push DATA [+] or [-] key. The minimum pitch signal will be saved to the CGY750. The display shows "!" when the stick is at the saved point. The minimum collective pitch setting must be saved into the CGY750 for F/F mixing and/or linkage compensation to function correctly.

SWASH BASIC MAP. 3/3

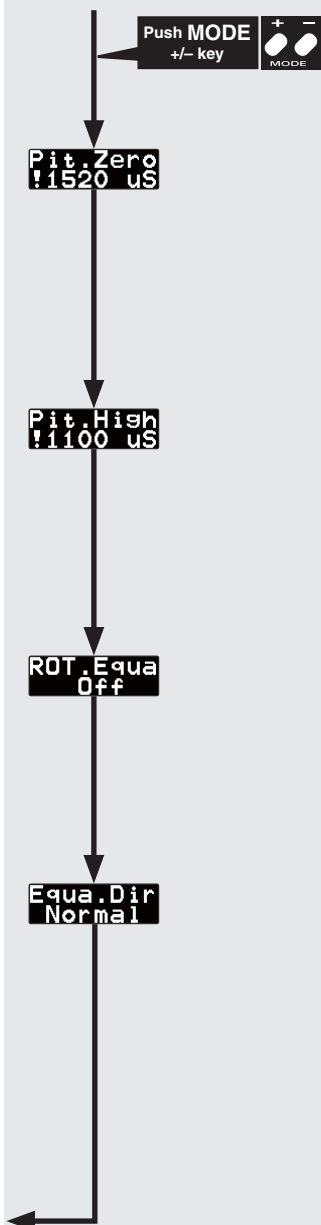

Rrturn to SWASH BASIC MAP. 1/3

(15) Pitch zero memorizing [default: 1520μS]

This parameter saves the zero collective pitch point into the CGY750. Move the collective pitch stick to zero degrees pitch and push DATA [+] or [-] key. The zero degrees pitch signal will be saved to the CGY750. The display shows "!" when the stick is at the saved point. The zero degrees pitch setting must saved into the CGY750 for F/F mixing and/or linkage compensation to function correctly.

(16) Pitch high memorizing [default: 1100μS]

This parameter saves the maximum collective pitch point into the CGY750. Move the collective pitch stick to maximum pitch and push DATA [+] or [-] key. The maximum pitch signal will be saved to the CGY750. The display shows "!" when the stick is at the saved point. The maximum collective pitch setting must saved into the CGY750 for F/F mixing and/or linkage compensation to function correctly.

(17) Rotational equalizer [default: off]

This function works to optimize pirouette stability during stationary and forward flight. Press the DATA [+] or [-] key to turn the function on or off.

(18) Equalizer direction [default: normal]

This function sets the rotational equalizer direction. Setting method: When the CGY750 is in this mode, the swashplate will tilt on direction and stay that way. Observe the direction of the tilt relative to the surface on which the model sits. Rotate the model 90 degrees about its mainshaft clockwise or counterclockwise. The swashplate should remain tilted in the **same direction** relative to the surface on which the model sits. Adjust Equa.Dir from NORMAL to REVERSE if needed to keep the swashplate tilt in the same direction as the model is rotated. Correctly setting of the rotational equalizer is critical for proper flight performance during pirouettes. All linkages from servos to swashplate should be installed prior to setting direction.

[confirmation of the direction]

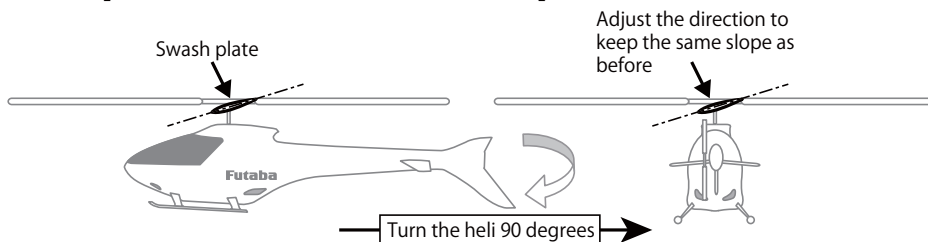

The CGY750 supports 6 different swash plate types as shown below.

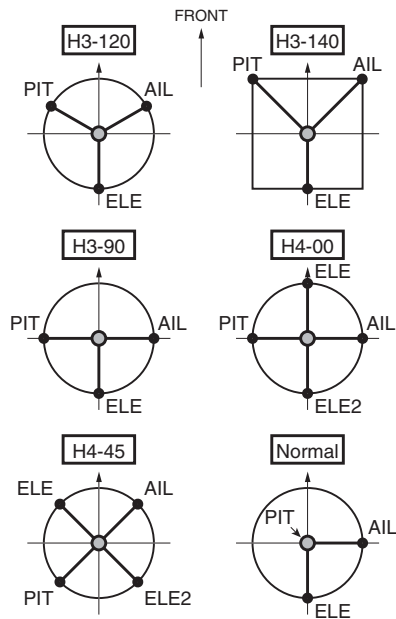

Swash Servo installation

- ❑ Determine which of the swash plate types shown match your helicopter and install the swash plate servos per the diagram and per your helicopter's instruction manual.
- ❑ Your transmitter should be reset to the default settings and the swash plate type selected with the transmitter should be set to Normal (H-1) or single servo mode. All CCPM mixing is set up and handled with the CGY750, and the transmitter functions should not be used. The expo function and dual rates can be used with the transmitter but everything related to the CCPM mixing should be set up and handled by the CGY750. Set your transmitter AFR, ATV and D/R (Swash functions) to 100% initially for setup, and all subtrims should be set to 0.
- ❑ Power up your transmitter and helicopter. Allow the CGY750 to initialize. Use the CGY750 [SWASHset Basic].
- ❑ Navigate to the Servo Type parameter on the CGY750 and select the servo type that matches your servo manufacturer's recommendations. If there is any doubt, select the analog servo type to prevent damaging the servos and check with your servo's manufacturer to determine the proper type.
- ❑ Navigate to the [SWASHset Basic] AIL.Ntr setting at this time. The AIL,ELE, or PIT.Ntr setting screens will each disable the gyros and cause the cyclic servos to remain in the center position. If you are using an electric motor, then it will be necessary to remove the pinion gear now or disconnect the motor from the ESC. Once you are certain that the drive motor cannot apply power to the main rotor blades, temporarily install servo arms onto the servos. Slowly move the collective stick towards positive collective and verify that each servo is moving in the proper direction to increase collective pitch. If the servos do not move in unison to maintain a level swashplate with a collective pitch input, choose another servo combination option from the ServoDir Comb# menu.

Once the servos are operating in the correct direction for the collective control (positive and negative), the next step is to slowly move the collective stick to the center position (verify within your transmitter's servo Display or Monitor function if possible). This will be considered the 0 collective position for setup. Temporarily install the servo arms onto the cyclic servos and ensure that the servos are perfectly level. Small adjustments can be made using the [SWASHset Basic] → AIL/ELE/PIT.Ntr adjustment for each servo if necessary. Mount the linkage ball onto the servo arm per your helicopter's instruction manual and install the servo retention screw onto each servo. Remember to use loctite on these screws if your servos have metal output gears.

- ❑ Move the forward / aft cyclic stick forward and verify that the swash plate tilts forward. If the swash plate tilts the wrong direction, then it will be necessary to reverse the sign of the [SWASHset Basic] ELE.Dir parameter (for example +50 would become -50). Move the left / right cyclic stick to the right and verify that the swash plate tilts to the right. If the swash plate tilts left, then reverse the sign of the [SWASHset Basic] AIL.Dir parameter. If the collective pitch movement is opposite to the transmitter input (positive stick input yields negative collective on the model), reverse the direction using SWS.Dir PIT.

As a final check, verify that the swash plate moves in the proper direction per your stick movements for the roll, pitch and collective functions.

- ❑ Navigate to the [SWASHset Basic] → SWS.Rate parameter. This will disable the gyros and cause the servos to remain centered during set up. Using a pitch gauge, ensure that the swash plate is perfectly level and that the main rotor blades are at 0 degrees pitch when the collective stick is centered. Make any mechanical adjustments as needed to achieve 0 degrees of pitch on both main rotor blades.

Rotate the main rotor blade with the pitch gauge so that it is aligned with the tail boom. Apply full right cyclic on the transmitter and measure how much pitch is on the blade. At least 9 degrees of cyclic pitch should be set. Adjust the value of the [SWASHset] → Basic → SWS.Rate parameter until at least 9 degrees of cyclic pitch is achieved.

OR.....Rotate the main rotor blade so that it is perpendicular to the tail boom and apply full aft cyclic. Adjust the [SWASHset] → Basic → SWS.Rate parameter until at least 9 degrees of cyclic is achieved.

Using the pitch gauge, adjust the collective range per your preference or per your helicopter's instruction manual.

All of the AFR, ATV and D/Rs for the cyclic and collective functions within the radio should be set to 100%. At this point the basic setup is complete, but it is necessary to set up the gyros and compensation directions before attempting to fly the model.

Navigate to the AGy.Dir and EGY.Dir parameters in the [Swashset Basic] menu.

These parameters control which direction the CGY750 (roll / pitch axis) will compensate when the helicopter rolls (pitches). Pick the helicopter up and roll the helicopter to the right. The CGY750 should compensate by adding left cyclic to the swash plate. (Pick the helicopter up and rotate the nose of the helicopter downward. The CGY750 should compensate by adding aft cyclic to the swash plate.) If the CGY750 compensates in the wrong direction, reverse the Compensation Direction setting by pressing the DATA [+] or [-] key once.

- ❑ Check the cyclic and collective movements for interactions and if any are noted please refer to the Swash Plate Adjustment (Linkage Compensation) procedure listed within the back of this manual. When using modern digital servos and with a proper setup, adjustments required will be minimal if any at all. Sometimes mechanical design flaws or mistakes within the setup will cause interactions, and it is best to remove these before flight.

AILERON / ELEVATOR GYRO SETUP

Finishing the setup:

Using the Remote Gain Functions (roll, pitch and yaw)

1. Some Futaba transmitters contain auxiliary gain functions for aileron, elevator and yaw. Please refer to your transmitter's instruction manual. Assign the GYR, GYR(AIL) and GYR(ELE) channels within the transmitter. Within the CGY750 [S.BUS] → Basic menu, assign the [AGN], [EGN] and [RGN] to the appropriate channels.
2. The gyro function within your transmitter should list all three gain channels. Adjustments can be made from within this function. The gyro function can usually be assigned to various switches or conditions to offer greater adjustability. Please refer to your transmitter's instruction manual for further details.
3. Initially the AIL and ELE gains should be set to 60% and the operating mode should be set to [NOR]. Once the trim process has been completed, the flight mode should be changed over to [AVCS]. When the AIL and ELE gyros are in CMT mode, [NOR] versus [AVCS] may be selected in the gyro menu in the transmitter (Futaba transmitters). Alternatively, [NOR] versus [AVCS] may be manually selected in the CGY750.

Setting the CGY750 gains by using endpoints or manual adjustments

⚠ WARNING

❗ Verify that the gyro compensates in the correct direction for all three axes before flight. If the compensation direction is incorrect, the model will roll, flip, or pirouette uncontrollably even before it leaves the ground.

1. If your transmitter does not support the remote gain adjustment it is still possible to use two spare channels on the transmitter to make the adjustments. Assign two unused channels (verify that these channels are not assigned or operated by a switch or dial) within the transmitter. Set the [S.BUS.Basic] → AGN and [S.BUS.Basic] → EGN channels to the appropriate channel. Use the end point adjustment within your transmitter for these channels to make the gain adjustments and the reverse function within the transmitter to set the mode [AVCS/NOR]. Conditions with the transmitter may also be used to achieve different gains based upon flight modes. Please refer to your transmitter's instruction manual for further details.

Manual gain adjustment

1. If your setup does not leave any channels free or if your transmitter does not support auxiliary gain adjustment, then it is possible to adjust the gain manually within the CGY750. Set both the [S.BUS].Basic → AGN and [S.BUS].Basic → EGN to [INH]. The gain adjustments are now made by entering the [AIL/ELE].Basic → Gain and pressing the data [+] or [-] keys.

The [Flight Tuning] → This menu contains all of the functions necessary to set up the CGY750 roll / pitch axis for operation.

FLIGHT TUNING MAP

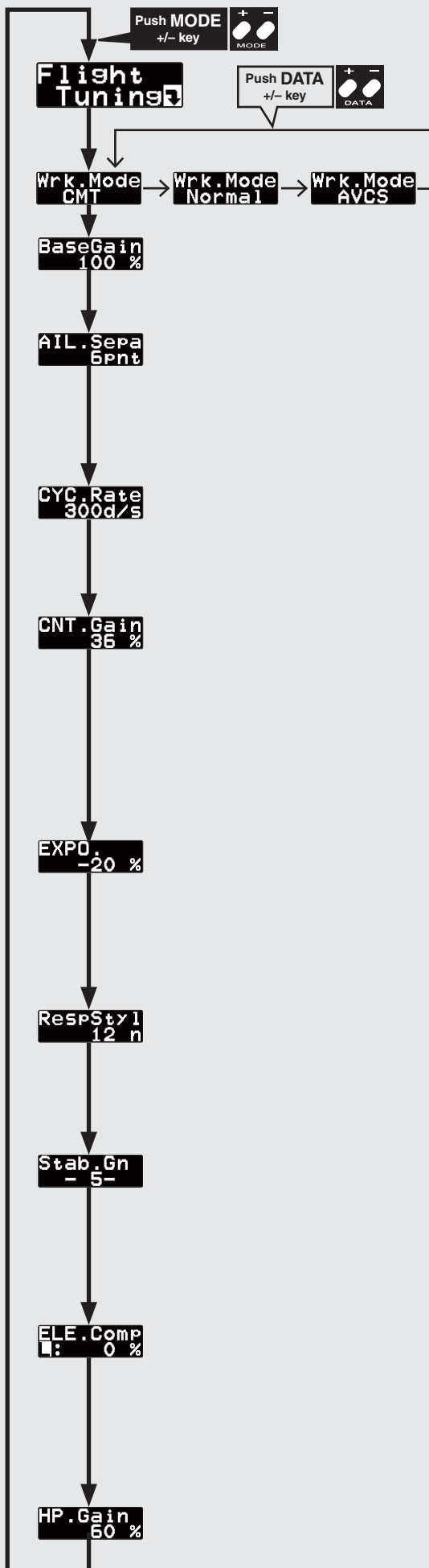

(1) Start display

The editing menus are scrolled by pushing the MODE+ or - key.

(2) Gyro working mode [default: CMT]

The available choices are CMT, Normal or AVCS. The CMT mode will allow you to select either AVCS or Normal mode via the transmitter. In Normal mode the gyro will always operate in Normal Rate Mode, and when AVCS it will always operate in AVCS Mode. Use the data [+] or [-] key to select the desired working mode.

(3) Gyro base gain setting [default: 100% ranges: 0~150%]

This sets the Cyclic Gyro Base Gain. If the aileron and elevator Gain Channels are set to [INH] within the CGY750 [S.BUS]->Basic setting menu, then the remote transmitter gain adjustment is not available. Thus the actual working gain for the cyclic gyros is set by using data [+] or [-] keys within this parameter

(4) Aileron gain separation [default: 6pnt ranges: 0~20pnt]

This parameter sets the aileron and elevator of the gyro gain separation. 6pnt means the aileron gain is lesser 6 points with elevator gain. It is useful when the aileron and elevator gain channels are set to same channel and aileron and elevator gain are adjusted at the same time. The rationale for this parameters lies in the fact that most models functionally will tolerate more gyro gain on the elevator axis than on the aileron axis

(5) Cyclic rate setting [default: 300d/s ranges: 100~500d/s]

Cyclic rate sets the maximum cyclic pitch and roll rate (d/s) as limited by the model's ability to reach that set rate. Pitch and roll rates are set together with this single parameter.

The second line shows the actual roll or flip rate for the roll or pitch axes for an aileron or elevator stick input.

(6) Control gain [default: 36% ranges: 10~100%]

Maximum roll and pitch rate are determined by CYC.rate, SWS.rate, head speed, model type, and blade choice. After the maximum desired pitch and roll rate are determined, control gain can be used to tune how aggressive the model feels when cyclic command is input. Ideally, the model's response to an initial input should feel proportional and linear to the maximum pitch or roll rate. For certain low(er) headspeed 3D set ups with some brands of blades, tuning the control gain to the 40% range may yield better overall hold during maneuvers and control feel, but the limiting factor for how high the value can be increased will be the appearance of nonlinear control feel or even oscillation during maneuvers. Adjust carefully.

(7) Exponential [default: -20% ranges: -100~0~+100%]

Tune the exponential as desired to soften or sharpen the feel of the cyclic controls around center stick. NEGATIVE values soften control feel; POSITIVE values sharpen control feel. Note that any exponential present in the TRANSMITTER adds to the value set in the CGY750. It is suggested that the exponential function in the CGY750 be used primarily to tune for a linear control feel, and that has been the goal of the default setting. From there if the pilot wishes to soften or sharpen the feel of the model around center cyclic stick, then the transmitter's exponential function would best be used.

(8) Response style [default: 12n ranges: 1~20n]

[RespSty] tunes the overall heading hold/AVCS effect of the system. Values of 8-12 n are compatible with moderate to aggressive flying styles and are good for most sport/3D flying. Note that with high(er) [RespSty] values, try to ensure that the swashplate is reasonably level prior to spool up.

(9) Stability gain setting [default: 5 ranges: 1~10]

Depending on many variables such as model, rotor blade design, head speed, head dampening, and servo choice, the amount of transmitter cyclic gyro gain that the model will tolerate without oscillation may be lower than the percentage that provides the most stable flight. If the model is observed to be oscillating or wobbling at your chosen headspeed with low transmitter cyclic gyro gain percentages, lowering the Stability.Gn parameter a point or two will allow for higher cyclic gyro gain without inducing a wobble or oscillation in the model.

(10) Elevator pre compensation [default: 0 ranges: 0~10]

This parameter sets the F/F (feed forward) mixing amount. There are 10 choices with increasing volume of mixing. The value selected automatically sets the F/F mixing volume for PIT→ELE. Correct mixing directions are previously determined by the AIL and ELE STK. Dir menus. When the F/F mixing value is 0, no mixing occurs. Adjust the ELE.Comp until the model climbs and descends with aggressive collective input without lifting or dropping its nose. Please avoid excessive amounts of ELE.Comp because it will adversely affect the model in other aspects of flight such as rolls.

(11) High pitch gain [default: 60% ranges: 0~100%]

HP.gain (high pitch) sets the cyclic gyro's internal control algorithm gain with high or low collective pitch inputs. Increasing this parameter's percentage results more holding power as collective pitch is input aggressively during aerobatics, but if its value is tuned too high, wobble or oscillation may occur.

Following your transmitter instructions, program your transmitter as follows:

- Enable the rudder gyro function within the transmitter.
- Set the gyro mode to AVCS (GY) within the transmitter.
- Set the remote gyro gain to 75% AVCS in the transmitter for the Normal and Hold flight conditions and use 50% AVCS for all idle up conditions. See "Setting the Gain" section later in this manual for more details.
- Set the Tail Rotor ATV/EPA to 100% for both left and right.
- Set D/R to 75% for both left and right. This will reduce the maximum pirouette rate. Make adjustments to these values once the initial test flight has been completed. Never use transmitter endpoint adjustments/ATV to adjust pirouette rate.
- It is recommended that you run 30% softening expo on the tail rotor channel.

⚠ WARNING

Do not connect the tail rotor servo to the gyro until the servo type has been selected. Operating the servo using the incorrect setting may damage the CGY750 or the servo.

The [RUD.Gyro].Basic menu contains all of the functions necessary to setup the CGY750 tail gyro for operation.

Remove all of the servo arms (cyclic servos and tail rotor servo) and linkages from the servo to prevent any possible damage. All analog servos must also be disconnected until the servo type has been set up within the CGY750. Power the system up and allow the CGY750 to initialize.

Plug your tail rotor servo into the rudder slot in the CGY750 control box. Install the servo arm, ensuring that the control ball linkage is perfectly perpendicular to the tail rotor push rod. Confirm that the direction of rudder servo movement with stick input is correct. Use your transmitter's servo reverse function if needed to achieve the correct movement.

Install the servo arm screw and place the linkage onto the control ball on the servo arm. Remember to use loctite on this screw if your servo has a metal output/final gear.

RUDDER GYRO BASIC SETTING

RUD GYRO BASIC MAP

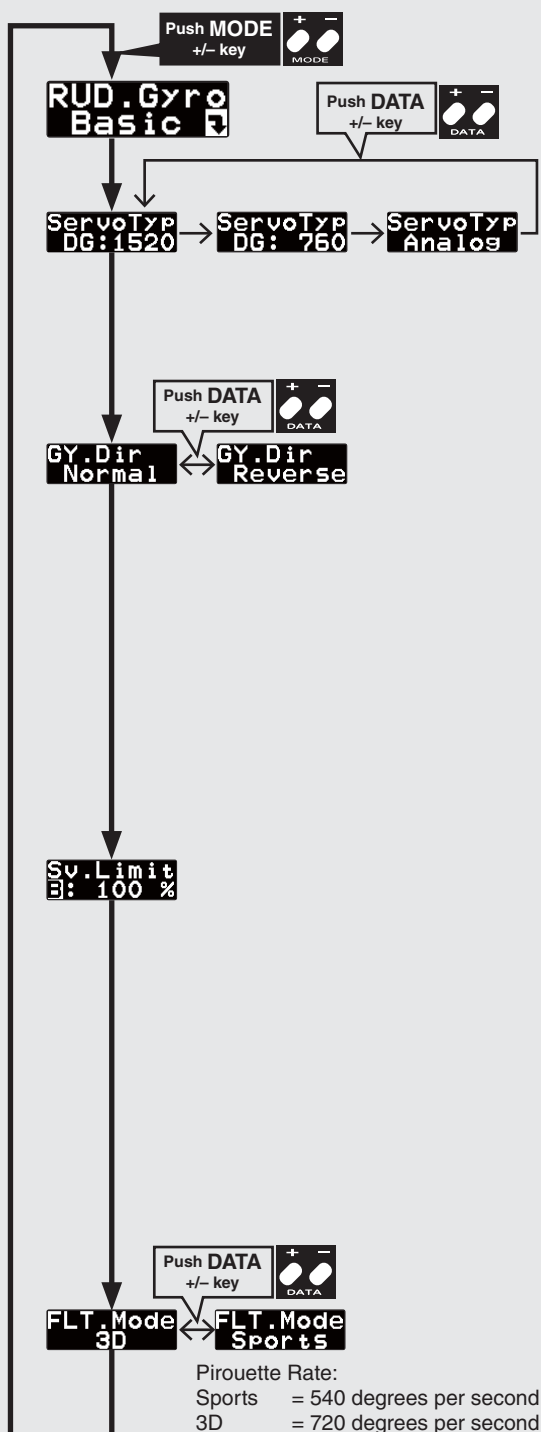

(1) Start display

Use the mode [+]/[-] keys to navigate the setting menus.

Navigate to the [RUD.Gyro].Basic menu

Read and follow step (2) [RUD.Gyro].Basic → ServoType

(2) Servo type [default: DG:1520]

Select the appropriate setting for the tail rotor servo that you are using. Use the data [+]/[-] key to choose from the following servo types: DG1520, DG760 or Analog.

DG 760: BLS276SV, BLS251SB, BLS251, S9256, S9251
DG 1520: BLS254, BLS257, S9254, S9257

⚠ WARNING

Read your servo instruction sheet to determine the proper servo settings. The servo type parameter within the CGY750 must match the type of servo you are using. Incorrect setting may damage the CGY750 or the servo. Incorrect setting may also result in a loss of control during flight.

Follow step (3) [RUD.Gyro].Basic → GY.Dir

(3) Gyro direction [default: Normal]

This parameter controls which direction the CGY750 (yaw axis) will compensate when the helicopter rotates. Hold the tail rotor linkage over the linkage ball on the servo, pick the helicopter up by the main shaft and rotate the mechanics counter-clockwise. The CGY750 should compensate by adding clockwise rotation pitch to the tail rotor blades. If the CGY750 compensates by adding counter-clockwise rotation pitch to the tail rotor blades, then it will be necessary to reverse the Compensation Direction setting by pressing the [+]/[-] data key.

⚠ WARNING

Verify that the tail gyro compensates in the correct direction before flight. If the compensation direction is incorrect the model will pirouette uncontrollably at lift off.

Follow step (4) [RUD.Gyro] → Sv.Limit to set the endpoint travel for each direction, ensuring no binding is present.

(4) Limit setting [default: 100%, setting range: 50~150%]

When the CGY750 is in the Sv.Limit parameter the gyro will no longer operate and the tail servo will always center when the tail rotor stick is released.

Always exit setup functions before attempting to fly the model. Before each flight always ensure that the gyros are operating and compensating in the correct direction.

The Servo Limit parameter within the CGY750 is used to set the mechanical limits for the tail rotor servo. To obtain the best performance it is recommended to set the limit in the CGY750 to 100% for both directions and then adjust the servo arm length to set the mechanical endpoints. After that has been completed use the servo limit parameter to make small adjustments that could not be made mechanically. Values between 90% and 110% are considered optimal. Navigate to the [RUD.Gyro].Basic → Sv.Limit menu and slowly move the rudder stick to the left or to the right maximum extent and use the data [+]/[-] key to increase or decrease the maximum throw respectively. Ensure that the pitch slider does not exceed the maximum extent of travel and cause binding.

⚠ WARNING

When using the CGY750 for the first time, or when making mechanical changes involving throw, you must check and set the servo limits again to prevent binding.

(5) Flight mode [default: 3D]

Selects the flight mode. Always try the "Sports" flight mode first and if you determine that the feel is not aggressive enough or if the pirouette rate is not fast enough then try the "3D" flight mode. The "Sports" Flight Mode will satisfy most pilots.

The flight mode is changed by pushing the data [+]/[-] key.

This menu sets the governor's fundamental functions. The menu *Servo limit point setting* must be set first.

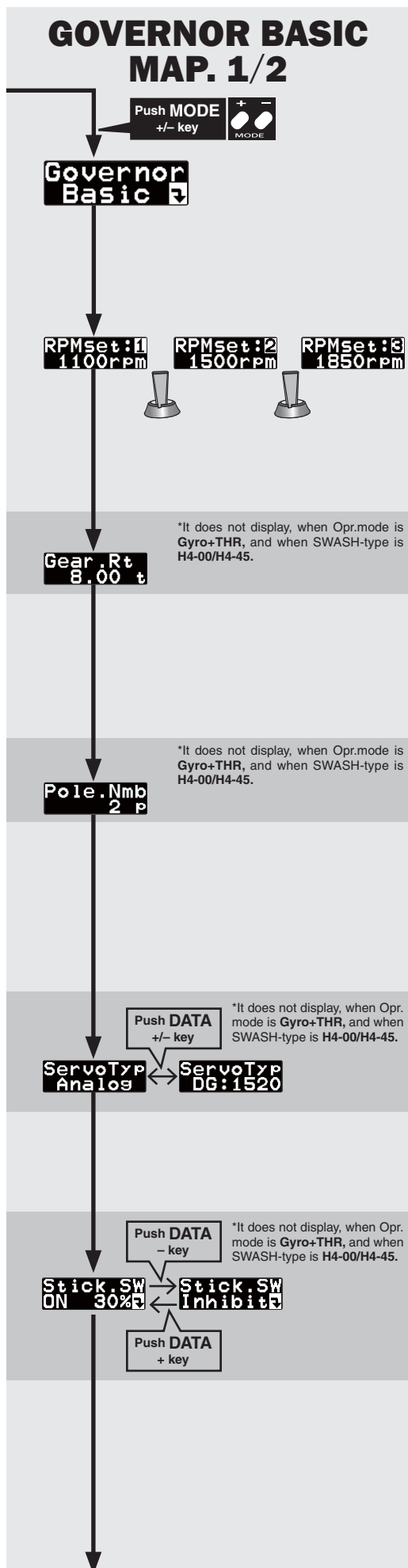

(1) Start display
The editing menus are scrolled by pushing the mode + or - key.

(2) Revolution setting [range: 700 ~ 4000 rpm]
Setting the main rotor revolution. This is calculated by engine revolution with the gear ratio of the main shaft.

(3) Gear ratio [default: 8.00, range: 1 ~ 50]
Input the main rotor gear ratio by pushing the data + or-key.

(4) Pole number [default: 2p, range: 2p ~ 24p]
This function sets the motor pole count. This function is used when employing a direct phase sensor attachment to a brushless motor lead. Input the motor pole count as specified by the brushless motor manufacturer. When using any revolution sensor other than a direct phase sensor type, set the pole number to 2p.
NOTE: The input signal range of the CGY750 is 0.0v-3.0v. Exceeding this voltage range may cause damage to the CGY750.

***Please see the Governor EXPERT menu in the ADVANCED TUNING SECTION at the end of this manual for additional guidelines for governor use with electric models.

(5) Servo selection [default: Analog]
Select the throttle servo type. Digital servos offer the best response. The type is changed by pushing data + or - key.

WARNING
⚠ This parameter must match the type of servo you are using. Incorrect setting may damage the CGY750 or the servo, possibly resulting in a loss of control during flight.

(6) Stick switch [default: 30%]
The governor can be activated by throttle stick position. Move the throttle stick to the desired governor on position and push SET key, memorizing that point. When you push the RSET key, the function is inhibited. When the governor on/off switch is inhibited, the stick switch is automatically turned on.

GOVERNOR BASIC MAP. 2/2

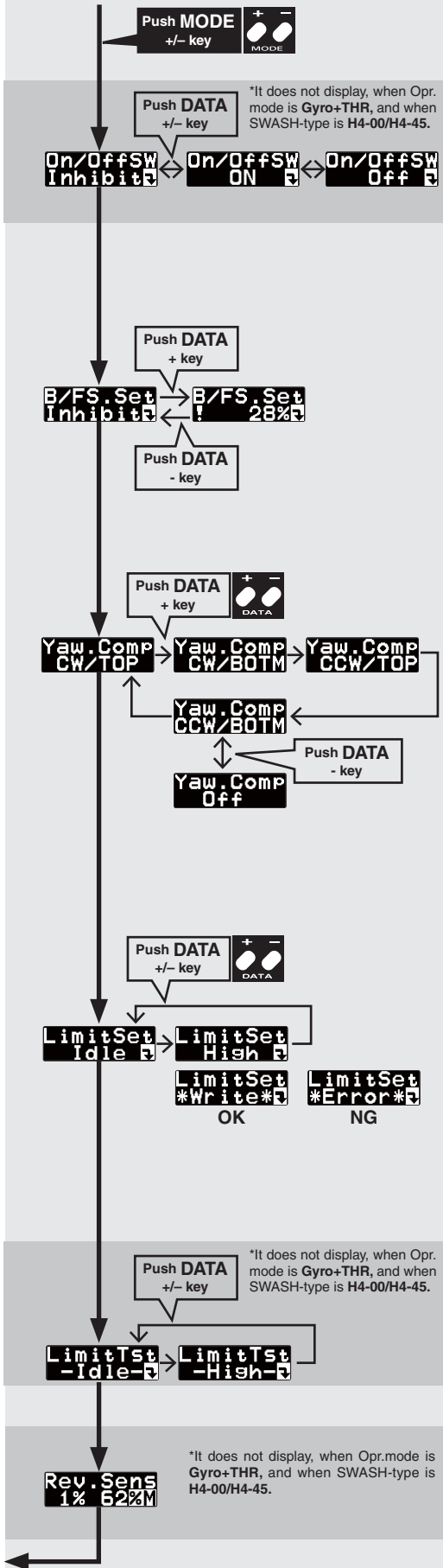

(7) Governor on/off switch [default: Inhibit]

This function allows turning of the governor on and off via a transmitter switch. Pushing the SET (Data+) key activates the function. The on/off direction is changed by pushing the SET key again. The function is inhibited by pushing the RSET (Data-) key.

(8) Battery failsafe setting [default: Inhibit]

The governor goes into the failsafe mode when the battery voltage is below BFS.Volt. When activated, the governor is deactivated, and the throttle servo is moved to B/FS position. When the throttle stick is moved to idle position, the B/FS condition is deactivated for 30 seconds and then returned to B/FS after 30 seconds have passed. Move the throttle stick to B/FS position as desired. Push set key to confirm the setting. Pushing RSET will inhibit the function.

(9) Yaw rate compensation [default: CW/TOP]

Yaw compensation allows the governor to more rapidly correct for changes in power demands of the model resulting from yaw input. Set the mode to match the gyro installing direction, either CW/TOP, CW/BOTM, CCW/TOP, CCW/BOTM by pushing the Set key. Pushing the RSET key inhibits the function. At the governor only mode, this function is inhibited.

- CW: clockwise rotor direction
- CCW: counter clockwise rotor direction
- TOP: Gyro top/name emblem facing up
- BOTM: Gyro top/name emblem facing down

(10) Servo limit point setting

⚠ WARNING

ⓘ When using the CGY750 for the first time, or when making changes in the throw of a servo and its linkage, always perform the limit setting operation.

Servo limit point setting defines the overall travel range for the throttle servo. It is fundamental for governor operation and must be set prior to other functions. Servo limits must also be reset when the throttle linkage or trim are changed.

For this setting, idling position is set first, then high position as guided by the display. Push the data + or - key to memorize. "Write" is displayed when the setting is completed. "Error" is displayed when the setting position is out of range (too little servo travel between low and high throttle positions).

(11) Limit point testing

Limit point setting confirms the throttle servo position at idle and full throttle. Push data + or - key. Throttle servo moves to the setting point indicated on the display.

(12) Revolution sensor testing

It tests the output level of the revolution sensor. Turn the engine by hand, and check the output level. The display indicates the current level on left side numbers, maximum level on right side numbers. The output level needs to be more than 60 % for correct governor operation.

Return to GOVERNOR MAP. 1/2

GOVERNOR SPEED SETTING

The CGY750's rpm selection is accomplished by setting the channel in the section (10) "Revolution channel" menu within the "*S.BUS Basic Setting*" to the governor speed setting channel of your system. When using an independent governor on/off switch, activate the section (6) "Governor on/off switch" function within the "*Governor Basic Setting*" section earlier in this manual.

Direct set by transmitter on Gov. mixing

- When governor mixing is used to switch the RPM of the rotor head speed, the head speed can be switched with each condition or the switch.

*For a description of the governor mixing, refer to your transmitter's manual.

Using by 3 position switch

- Set the RPM at each switch position in the "(2) Revolution setting" menu within the "*Governor Basic Setting*" section earlier in this manual.

Speed setting precautions

- When the speed setting channel travel (EPA, ATV, AFR) is set to 20% or less, points 1 and 3 cannot be set.
- The engine maximum speed range limits the maximum speed setting.
- Test fly the helicopter with the governor turned off and tach the main rotor R.P.M. while in horizontal flight. This is the maximum R.P.M. that can be achieved with the engine and pitch setup that you are using. Please set the governor maximum speed to approximately 50 R.P.M.'s less than max R.P.M. (Example: If 1800 R.P.M.'s is max, then set governor to 1750)
- The maximum speed can be verified at the MAX. speed display. However, this value could reflect an unlocked main rotor condition and would thus be inaccurate.

Reference

The transmitter ATV/EPA function can also be used to change the point 1 and point 3 speed settings to a certain extent. The amount of this change is proportional to the difference between the point 1 and point 3 set speed and the point 2 set speed. For example, if point 1 is set to 1300rpm and point 2 is set to 1500rpm, and the transmitter ATV is changed from 20 to 100%, the point 1 speed will change from 1460 to 1300rpm. The transmitter ATV function has very little effect on the point 2 speed setting. The speed changes linearly on a line connecting points 1, 2, and 3.

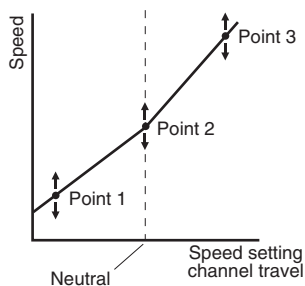

GOVERNOR OPERATION

Governor operation

The CGY750 operates from 700 to 4000rpm main rotor speed. However, the engine must be running at the set speed. The CGY750 turns off the governor when the engine is starting or idling.

* Governor operation: Operation that stabilizes the engine speed at the set speed.

Condition of the governor to be on

For safety purposes, the governor is turned on when the conditions below are satisfied.

- The on/off switch conditions are set to off during power on.
- The stick switch is in the on position when it is used.
- The on/off switch is in the on position when it is used.
- Setting speed is not off.
- The engine speed exceeds to 60 % of the setting speed.
- The speed sensor is working properly.

The following operations do not indicate trouble:

When engine speed rises above the set speed:

A near-vertical dive may cause the engine speed to exceed the set speed.

Throttle operation speed and ON/OFF point:

If throttle operation exceeds 60% of the set speed and the rotor speed rises to the set value, the ON/OFF point may seem to differ with the operating speed. Delay operation to smooth the switching operation causes this and does not mean that the ON/OFF point has changed.

Deviation from set speed:

The CGY750 stabilizes the engine speed to within $\pm 1\%$ of the set speed. For example, if the rotor R.P.M. is set to 1500rpm, the Rotor R.P.M. speed will deviate about ± 15 rpm. However, this poses no problem from the standpoint of practical use.

WARNING

⚠ Safety reminder: Remember to configure your transmitter fail safe settings for not only the throttle channel but also governor ON/OFF channel to ensure the governor correctly disengages should the radio enter fail safe.

RECOMMENDED GYRO GAIN SETTINGS

Recommended gain settings:

Size	Recommended Gyro Gain
	AIL/ELE Gyro
450-550	50-60.00%
600-700	50-60.00%
750-more	50-60.00%

50% is a good starting point for rudder gain regardless of model size.

BEFORE FLIGHT CHECKLIST

- Always verify that the transmitter and Receiver batteries are fully charged.
- Check the gyro mounting tape and ensure that it is in good condition. Make sure the gyro is firmly mounted to the helicopter.
- Verify that the gyro wiring has some slack in it and all wires are clear of the main frame.
- Power on the transmitter and receiver. Allow the gyro to initialize.
- Check and verify that the servo type parameter is set correctly for the tail rotor and cyclic servos.
- Verify that all of the servo arm screws are installed.
- Ensure that the cyclic and tail rotor servos do not bind when moved to the full extent of the throw.
- Verify that the gyro is operating in the correct mode [AVCS or Normal] and that the gains are properly set.
- Test all controls and verify that they move in the correct direction.
- Verify that the gyro compensates in the correct direction for all three axis before flight. If the compensation direction is incorrect the model will roll, flip, or pirouette uncontrollably, at a very high rate.

ADJUSTMENTS DURING THE TEST FLIGHT

WARNING

⚠ Always level the swashplate using the cyclic stick before applying throttle and spooling the main rotor blades up. During takeoff small corrections may be necessary. If you make large corrections while the helicopter is on the ground, it may tip over since the helicopter is firmly on the ground and the gyros are overcompensating due to the lack of movement.

⚠ Some helicopters may have a tendency to resonate/shake during spool up. Always leave the helicopter on the ground until this resonance or shaking goes away. If this issue continues, it is recommended to try some rubber skid stops or take off from a softer surface such as grass. Vibrations contribute to this ground resonance. Verify that everything on your model is balanced correctly.

*When the CGY750 is used with a ESC or BEC and a power switch is not used there is a possibility that the intermittent connection as you connect the flight battery may cause the CGY750 initialization to fail. Always ensure that the gyro has initialized properly by verifying that the gyros are compensating as the helicopter is moved. It is recommended to use a power switch on the power supply line to avoid this possibility.

Trim flight:

A trim flight should be performed on a new setup or when making setup changes to the mechanical adjustments on the helicopter.

1. Verify that the AIL and ELE gyros are set to 50% gain and the Normal operating mode. Take the model off into a hover and use the transmitter trim tabs to trim the model during flight. The most accurate trim flight is accomplished in calm wind conditions.

2. Once the model is trimmed out, land the model and shut the engine off. Move the gyro gain switch from Normal to AVCS mode 3 times in a second. Make sure the neutral positions for both aileron and elevator are memorized. Do not center the trims after memorizing their positions into the CGY750.

*If your gyro gain switch is on the flight mode switch, perform the trim flight and land the model. Shut the engine off and change the CGY750 operating mode to AVCS. Now turn the CGY750 off and back on. The neutral positions for both aileron and elevator will be memorized.

*Manual Gain Adjustment: Perform the trim flight and land the model. Shut the engine off. Change the CGY750 operating mode to AVCS. Now turn the CGY750 off and back on. The neutral positions for both aileron and elevator will be memorized.

3. After the trim flight, change the gyro operating mode to AVCS and test fly the model again. Increase the gain on the aileron and elevator gyro until you notice a oscillation, then decrease the gain slightly. Keep the AIL and ELE gyro gains set to the same value.

*In case of lack of the channel for gyro gain setting on the transmitter, adjust the gyro gain on the CGY750.

Rudder gyro adjustments:

The tail rotor/rudder AFR or D/R function within the transmitter is used to adjust the pirouette rate of the helicopter to suit your requirements. Do NOT use ATV or rudder channel travel adjustment for this purpose. For optimum performance, the tail rotor should be trimmed in Normal/Rate mode as closely as possible with adjustments to the tail rotor pushrod length before finalizing with transmitter trim and then memorizing that value into the CGY750.

The tail rotor gyro gain should be raised until the tail begins to oscillate quickly (also called tail “wag”). Once this point has been achieved, reduce the gain as needed a few percent at a time to eliminate the oscillation. Repeat the process for all flight conditions. The main rotor speed, tail rotor ratio, tail rotor pitch range and tail blade length play a large part in achieving optimum tail rotor performance. The gain value can vary drastically from model to model, and the exact value should not play a part in the evaluation of the gyro’s performance.

❑ V1.4 firmware for the CGY750 has been exhaustively tested to NOT require tuning of numerous parameters to achieve good flying performance. Nonetheless, the wide variations in model, blade, and radio equipment types may dictate the need for a small amount of fine tuning to yield the best model performance.

❑ Static cyclic pitch should be measured in the SWS.Rate section of the SWASHset BASIC menu ONLY. Suggested cyclic pitch range should be at least 9-10 degrees on each side of neutral with an acceptable working range for the SWS.rate of 50-70%. Cyclic pitch ranges in excess of 10 (maximum of 12) degrees within this 50-70% range are not problematic as long as no swashplate or other linkage binding occurs. Previous recommendations of 8-9 degrees of cyclic pitch are not applicable to this firmware and will yield inadequate cyclic rate and poor performance. Use your transmitter’s AIL and ELE AFR’s or dual rates to fine tune cyclic rates to your needs. Observed cyclic travel when the CGY750 is NOT in the SWS.Rate menu will be several degrees more than the measured static pitch.

❑ Total gyro (transmitter) gain for AIL and ELE should initially be set to 50-60%. It is also suggested that the gyro gains for AIL and ELE be set to matching percentages. AIL.Sepa will facilitate being able to keep the AIL and ELE gyro gains at similar percentages.

❑ Proper response of the elevator axis to control input with avoidance of bounce is achieved with adjustment of D gain. If the bounce is slow at the end of an elevator cyclic input, increase the D gain until the bounce disappears. The limit of D gain adjustment comes when a fast and/or harsh bounce is observed instead of a crisp stop. Please note that any flybarless or even a single axis tail rotor gyro will exhibit bounce if total gyro gain is too high. If you have tuned D gain as well as possible and still have a little bounce, a simple reduction in total gyro gain will almost assuredly remove the remaining bounce.

❑ In addition to the ELE.Comp mixing in the Flight Tuning Menu, V1.4 firmware also has available in the AIL and ELE Expert mixing sections AIL, FLIP, and ROLL compensation mixers. Instructions for tuning these mixers are found on p 22 of this manual. These mixes will not be needed in most cases because the further enhanced holding ability of V1.4 firmware. If any tendency is observed for the model to corkscrew in rolls, deviate off axis during flips, or roll off during ascents or descents, adjustment of one or more of these mixers will eliminate the issue(s). Remember to teach the CGY750 the directions for UP ELE and RIGHT AIL commands in the STK.Dir menu (SWASHset BASIC) and memorize them into the system by pressing either the [+]or[-]DATA button.

Expert Gyro and Governor Definitions and Tuning Section

RUDDER GYRO EXPERT SETTING

The rudder Expert menu contains settings for pilots looking to achieve the absolute best performance from their gyro and tail rotor system. To enter the Expert menu first navigate to the Basic menu and then press and hold the mode [+] key for one second. The menu will change from the Basic to Expert. To exit the Expert menu press and hold the mode [+] key for one second and the Basic menu will be displayed.

RUD GYRO EXPERT MAP 1/2

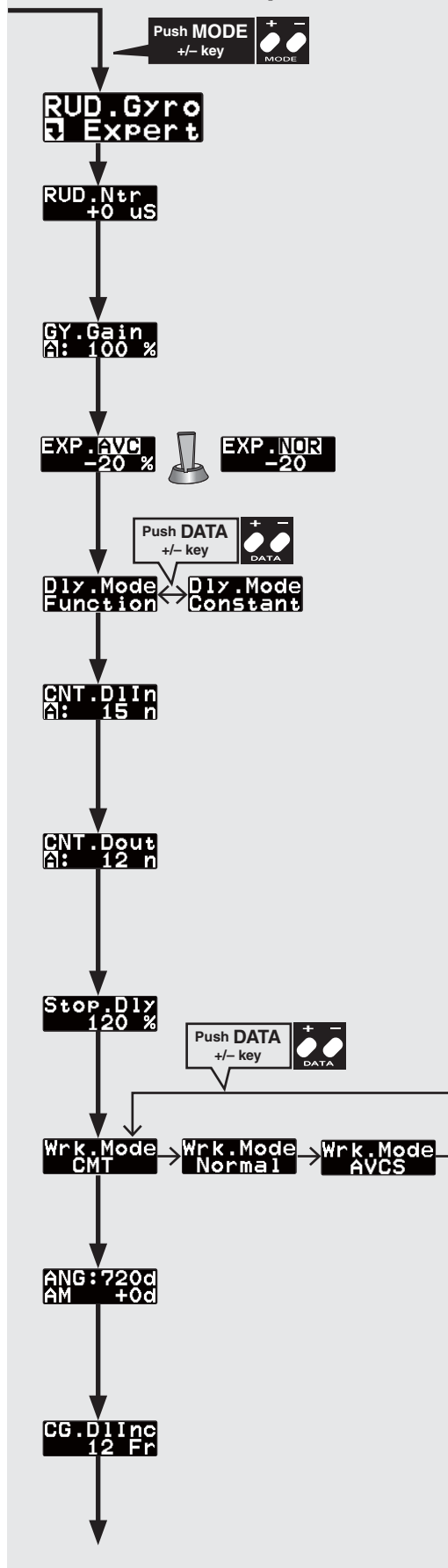

(1) Rudder gyro expert setting: start display

Use the mode [+] or [-] keys to navigate through the menu.

(2) Rudder servo neutral setting [default: 0 μ S] [ranges: -140 μ S ~+140 μ S]

This parameter is used to set the neutral position of the rudder servo. Position the rudder servo arm as perpendicular as possible to tail rotor pushrod prior to making adjustments with this parameter. Press the data [+] or [-] key to make adjustments.

(3) Gyro basic gain [default: 100%] [ranges: 50% ~ 120%]

This parameter sets the base gain of the gyro. This can be used to adjust the gain % if your actual transmitter gain does not match the gain on the CGY750 correctly.

(4) Rudder exponential [default:-20% (3D-AVCS), -20% (3D-Normal), -60% (Sports-AVCS), -40% (Sports-Normal)] [ranges: -100% ~ +100%]

This parameter sets the feel of the tail rotor control around center. Decreasing the number (less negative) will result in a quicker feel off center and increasing the number will result in a softer feel. Adjust to suit your preference. The RUD EXP functions within your transmitter can also be used to make this adjustment.

(5) Rudder delay mode [default: Function]

Select [Function] for a softer control feel and [Constant] for a linear and aggressive feel.

(6) Control delay In [default: 3D=15, Sports=12] [ranges: 0 ~ 20]

This parameter sets the delay as you move the stick from neutral toward left or right. Larger values result in a softer tail rotor feel off center. This parameter must be adjusted individually for LEFT and RIGHT tail rotor commands. Use the data [+] or [-] key to adjust the value.

(7) Control delay Out [default: 3D=12, Sports=10] [ranges: 0 ~ 20]

This parameter sets the delay when the stick is returned back to the neutral position. This parameter is useful to tune how aggressively the tail rotor stops following a pirouette. The higher the value, the softer the stop. This parameter must be adjusted individually for LEFT and RIGHT tail rotor commands. Use the data [+] or [-] key to adjust the value.

(8) Stop delay [default: 120%] [ranges: 100% ~ 400%]

This parameter may also be used to adjust the aggressiveness of the stop but is individually NOT tuneable for LEFT versus RIGHT tail rotor commands. Larger values will soften the tail stops resulting in less bounce. Use the data [+] or [-] key to adjust the value.

(9) Gyro working mode [default: CMT]

This parameter sets the gyro operating mode. The choices are CMT, Normal and AVCS. The CMT function is used when you need to switch between the Normal and AVCS modes via the transmitter. Use the data [+] or [-] key to select the operating mode.

(10) Pirouette speed [default: 3D=720deg/sec, Sports=450deg/sec] [ranges: 100~999deg/sec]

This parameter adjusts the maximum pirouette speed of the tail rotor that the gyro will allow. The default values are set 450 deg/sec in Sports mode and 720 deg/sec in 3D mode when rudder AFR/DR is 100 %. The bottom of the line shows the actual pirouette speed of the rudder. Use the data [+] or [-] key to adjust the maximum commanded pirouette rate.

(11) Gain change up delay [default: 12] [ranges: 1 ~ 50]

This parameter sets the delay of change of the gyro gain from low to high when switching from idle up to hover and helps avoid the chance for tail rotor hunting during this switch. Use the data [+] or [-] key to adjust the value.

Expert Gyro and Governor Definitions and Tuning Section

RUD GYRO EXPERT MAP 2/2

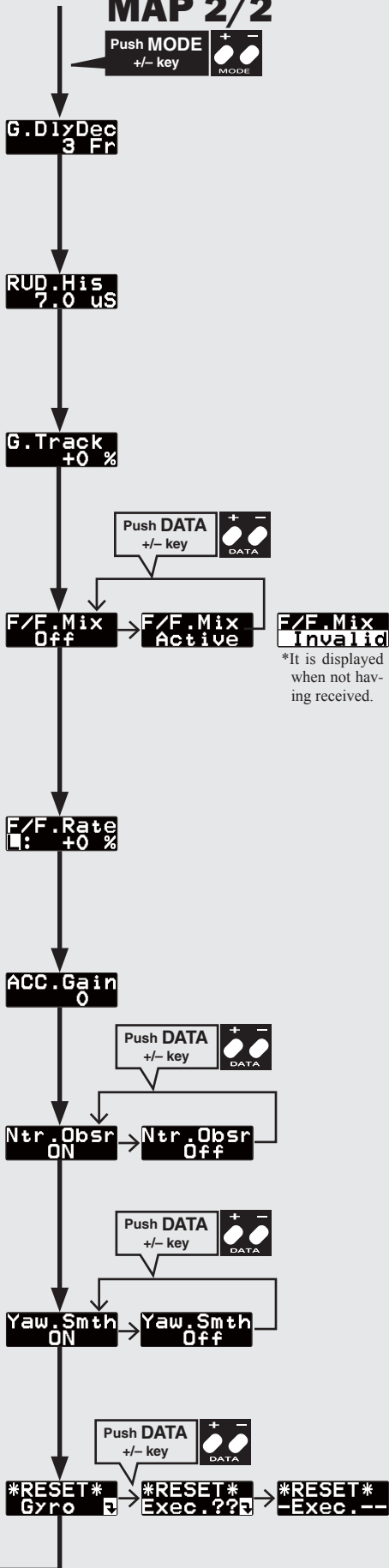

(12) Gain change down delay [default: 3] [ranges: 1 ~ 50]

This sets the delay of the gyro gain from high to low as would occur during a switch from hover into idle up and helps prevent the tail from feeling "loose" while the head speed accelerates to the higher rate. Use the data [+] or [-] key to adjust the value.

(13) Rudder hysteresis [default: 7 uS] [ranges: 0 uS ~ 50 uS]

Hysteresis adjusts the range right around center of tail rotor stick travel within which a tail rotor input will result in no rudder servo movement. The greater the value, the wider the range where stick movement yields no servo movement. Use the data [+] or [-] key to adjust the value.

(14) Gain tracking [default: 0%] [ranges: -20% ~ +20%]

Gain tracking is another method to adjust how the tail rotor stops. For example, when there is a bounce when stopping a left pirouette or the helicopter coasts when stopping right pirouette, increase gain tracking in the + direction. In the opposite situation, shift the gain tracking in the - direction.

(15) F/F mixing [default: off]

Feed Forward mixing is activated with this parameter. F/F mixing is a pitch to rudder mix applied outside of the gyro compensation's control loop and before the gyro itself can even sense undesired tail rotor movement. F/F mixing is handled within the CGY750. Do not attempt to use revolution or acceleration mixing within your transmitter as this will actually adjust the input signal to the gyro and cause drifting.

(16) F/F mixing rate [default: 0%] [ranges: -100% ~ +100%]

This parameter adjusts the F/F mixing rate. The [L] low and [H] high rates are adjustable individually. Larger values will add more mixing as the collective is moved away from center towards + or - pitch.

(17) F/F mixing acceleration gain [default: 0%] [ranges: 0 ~ 200%]

Acceleration gain is used to increase momentarily the F/F mixing rate to help compensate for abrupt changes in collective pitch. Use the data [+] or [-] key to adjust the value.

(18) Neutral compensation [default: on]

This function works to recall the neutral point of the rudder servo for improving tail stop motion. To use this function effectively, hover the helicopter for about one second, and memorize the neutral point. If flying a 3D helicopter, this function may not work as well due to the quick and aggressive movements, so test with it turned on and off and decide which yields better stop behavior. Use the data [+] or [-] key to enable or disable this option.

(19) Yaw smoother [default: on]

This function selects the rudder control feeling. When turned on, rudder control becomes more exact. When turned off, rudder control authority increases. Select the rudder control feeling to your taste. Use the data [+] or [-] key to enable or disable this function.

(20) Gyro data reset

This parameter resets all of the rudder gyro parameters back to the default values. Press the data [+] key once and [Exec ??] is shown as a confirmation. Press the data [-] key again to confirm the operation, and all of the gyro parameters will be reset.

Expert Gyro and Governor Definitions and Tuning Section

AILERON AND ELEVATOR EXPERT SETTING

The Expert AIL and ELE menus allow further refinement of cyclic gyro performance. It should be stressed, however, that the default values for the listed parameters will yield excellent performance for the vast majority of models. To enter the AIL or ELE Expert menu, navigate to the Flight Tuning menu and then press and hold the MODE [+] or [-] key for one second. The menu will change to AIL Expert. Select between AIL or ELE Expert menus by pressing the DATA [+] or [-] key. To exit the AIL or ELE Expert menus press and hold the MODE [+] or [-] key for one second.

AIL/ELE EXPERT MAP

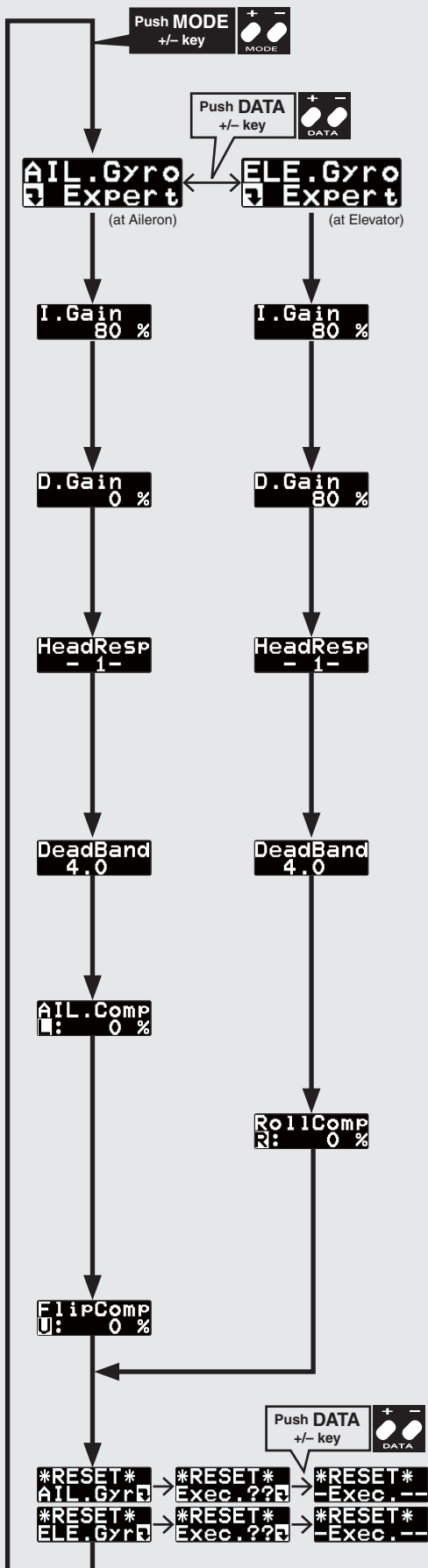

(1) Aileron and Elevator gyro expert setting: start display
Use the MODE[+] or MODE[-] keys to navigate through the menus

(2) I gain <integral gain> [default: AIL 80% ELE 80%] [ranges: 0% ~ 200%]
I gain tunes the ability of the model to maintain a given heading. Inadequate I gain results in a change in model heading especially with aggressive collective pitch input. Excessive I gain can result in oscillations in forward flight or with cyclic input. On the ELE axis especially, excessive I gain can create bounce.

(3) D gain <differential gain> [default: AIL 0% ELE 80%] [ranges: 0% ~ 250%]
D gain is best used to tune the stops following cyclic commands. Inadequate D gain results in soft, indeterminate stops possibly with a slow bounce. Excessive D gain causes harsh stops with a quick bounce or oscillation in forward flight or with cyclic input.

(4) Head Response [default: AIL 1 ELE 1] [ranges: 1 ~ 10]
Head response tunes the rate of data flow between the flybarless controller and the servos. In general the default values for head response should be maintained because they yield the best response to control input. However, if certain brands of non-Futaba servos are observed to be running excessively warm and current consumption per flight is high, then higher head response values will ease the issue. Excessively high head response values will cause unacceptable lags in model response to control input

(5) Dead band [default: 4.0µS] [ranges: 0µS ~ 25.0µS]
Dead band sets the null/non-responsive range of the stick. When the center stick feeling is too unsettled, increasing the deadband will calm that feel. Note that excessive deadband will result in a disconnected feel of the model to small stick inputs.

(6) Aileron compensation [default: 0%] [ranges: 0%~ 100%] (Aileron expert)
This function sets the mixing rate of the pitch to aileron mixing. The roll axis may be affected by positive/negative collective pitch movement as manifested by the model rolling off either to the left or to the right during rapid ascent or descent. This mixing compensates this effect. The mixing amount can be adjusted individually for both positive and negative collective pitch inputs.

Roll compensation [default: 0%] [ranges: 0%~ 100%] (Elevator expert)
This parameter sets the mixing rate of the aileron to elevator mixing. The elevator axis may be affected by the aileron input as manifested by a tendency for the model to corkscrew or otherwise roll non-axially. This mixing compensates this effect. The mixing amount can be adjusted individually for both left and right aileron inputs.

(7) Flip compensation [default: 0%] [ranges: 0%~ 100%] (Aileron expert)
This parameter sets the mixing rate of the elevator to aileron mixing. The roll axis may be affected by a pitch axis (elevator) input as manifested by the model rolling off to the left or right during flips or loops. This mixing compensates this effect. The mixing amount can be adjusted individually for both up and down elevator stick inputs.

(8) Data reset
This menu resets all of the aileron (elevator) gyro parameters back to the default values. Press the data [+] key once and [Exec ??] will be shown as a confirmation. Press the data [+] key again to confirm the operation and that all of the gyro parameters have been reset

Expert Gyro and Governor Definitions and Tuning Section

SWASH EXPERT SETTING

The swash expert menu contains settings for pilots looking to achieve the absolute best performance from their gyro by precisely adjusting swash-plate movement so as to virtually eliminate adverse flight behavior during some maneuvers such as roll or loops/flips. Items (1) – (15) are used to keep the swash plate level at high and low collective pitch and to reduce or eliminate PIT → cyclic and AIL → ELE and ELE → AIL cyclic eCCPM interactions. To enter the Expert menu, navigate to the Basic menu, press and hold the mode [+] key for one second and the menu will change from the Basic to Expert. To exit the expert menu press and hold the mode [+] key for one second and the basic menu will be displayed.

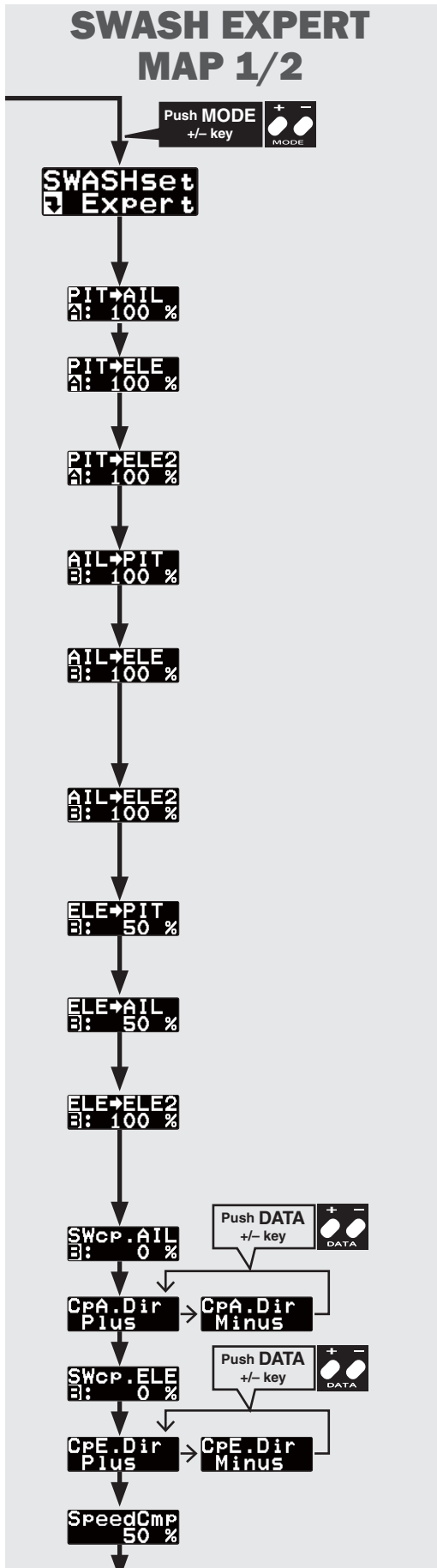

(1) Swash expert setting: start display

Use the mode [+] or [-] keys to navigate through the menu.

Note: Items (2)-(15) and how to adjust are described in detail in the Linkage Compensation Section that follows the Swash Expert Setting section.

(2) PIT→AIL mixing rate [default: 100%] [ranges: 30% ~ 150%]

(3) PIT→ELE mixing rate [default: 100%] [ranges: 30% ~ 150%]

(4) PIT→ELE2 mixing rate [default: 100%] [ranges: 30% ~ 150%]

This parameter adjusts the pitch to 2nd elevator mixing rate. The rates can both be adjusted individually for both full high and low collective positions. It is only available at H4 swash mode.

(5) AIL→PIT mixing rate [default: 100%] [ranges: 30% ~ 150%]

(6) AIL→ELE mixing rate [default: 100%] [ranges: 30% ~ 150%]

This parameter adjusts the aileron to elevator mixing rate. The rate can be adjusted for left and right directions individually. It is only available for H4-45 swash mode.

(7) AIL→ELE2 mixing rate [default: 100%] [ranges: 30% ~ 150%]

This parameter adjusts the aileron to 2nd elevator mixing rate. The rate can be adjusted for left and right directions individually. It is only available for H4-45 swash mode. It is only available for H4-45 swash mode.

(8) ELE→PIT mixing rate [default: 50%(H3-120), 100%(except H3-120)] [ranges: 30% ~ 150%]

(9) ELE→AIL mixing rate [default: 50%(H3-120), 100%(except H3-120)] [ranges: 30% ~ 150%]

(10) ELE→ELE2 mixing rate [default: 100%] [ranges: 30% ~ 150%]

This parameter adjusts the elevator to 2nd elevator mixing rate. The rate can be adjusted for up and down directions individually. It is only available for H4 swash mode. It is only available for H4 swash mode.

(11) Linkage compensation aileron [default: 0%] [ranges: 0% ~ 100%]

(12) Compensation direction of the aileron [default: plus]

(13) Linkage compensation elevator [default: 0%] [ranges: 0% ~ 100%]

(14) Compensation direction of the elevator [default: plus]

(15) Speed compensation [default: 50%(H3-120), 0%(except H3-120)] [ranges: 0% ~ 100%]

Expert Gyro and Governor Definitions and Tuning Section

SWASH EXPERT SETTING

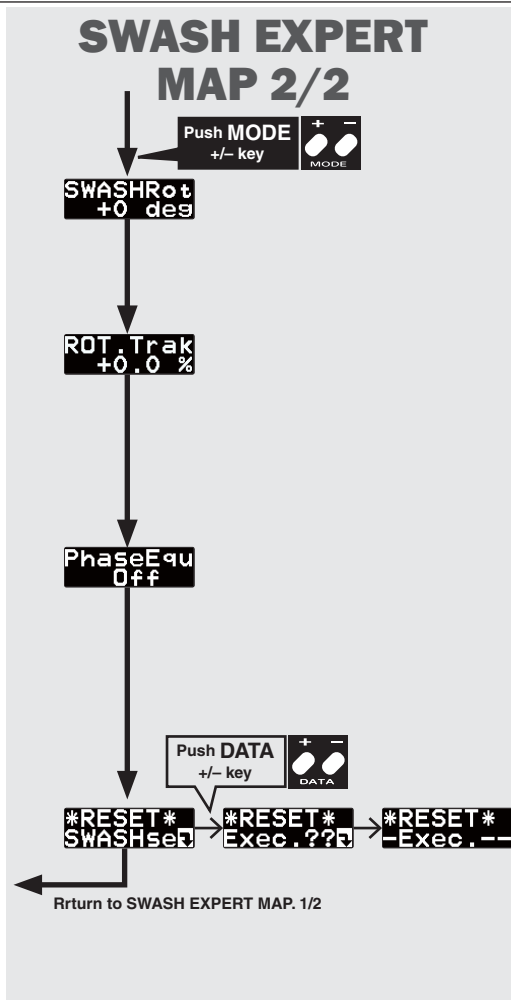

(16) Swash rotation [default: 0 deg] [ranges: -90 deg ~ +90 deg]

This parameter is used to adjust the control phasing. Use the data [+] or [-] keys to make adjustments.

(17) Rotational tracking [default: 0%]

This function tunes the rotational equalizer to the pirouette characteristics of the model. When pirouetting the model at the desired rate, observe the model's rotor DISK (NOT the mechanics) and tune the ROT.Trak until the disk stays flat during the pirouette. Find the best average setting for both left and right pirouettes

(18) Phase equalizer [default: off]

This function optimizes swashplate phasing during pirouettes. Press the DATA [+] or [-] key to turn the function on or off.

NOTE: This function needs rotor head RPM and direction of rotation to work correctly, so please set the rotor head RPM and direction in the governor menu. Note that rotor head speed information must still be set into the CGY750 governor menu even if using an electronic speed control (ESC) with an electric model.

(19) Data reset

This resets all of the Swashplate parameters back to the default values. Press the data [+] key once, and [Exec ??] is shown as a confirmation. Press the data [-] key again to confirm the operation and all of the gyro parameters will be reset.

LINKAGE COMPENSATION

The following section describes in detail the adjustment of the Linkage Compensation Menu to virtually eliminate an interactions present in the eCCPM model.

*Prior to making any adjustments within this menu, the aileron, elevator and pitch movement should be set to full travel in the transmitter (AFR/dual rates set to 100%).

Pitch calibration (This should be set prior to the compensation process)

- This parameter reads the collective pitch operation ranges to the CGY750. Move the collective stick to center position (Pitch zero point). Open the Pit.Zero on the SWASHset Expert menu and push the set button. The pitch zero point is memorized to the CGY750.
- Move the collective stick to minimum position. Open the Pit.Low menu and push the set button. The minimum pitch position is memorized.
- Move the collective stick to maximum position. Open the Pit.High menu and push the set button. The maximum pitch position is memorized.

Pitch movement calibration

- Make sure the swash plate is level when the collective stick is center position at first. Adjust the length of the linkage rods so that the swash plate is level.
- Move the collective stick to maximum position. Make sure if the swash plate is level by adjust if needed using the PIT → AIL and/or PIT → ELE mixing rate in the SWASHset Expert menu. Move the collective stick to minimum position and once again use the mixing rates to achieve a level swashplate.

Aileron movement calibration

- Move the collective stick to center position. Move the aileron stick right and left.
- When a left or right AIL command is input, you may observe an AIL → PIT interaction. Adjust the AIL → PIT mixing rate in the SWASHset Expert menu to minimize the interaction. The mixer should be adjusted for both left and right AIL directions.

- Move the collective stick to the maximum position. Open the SWcp.AIL on the SWASHset Expert menu. Move the aileron stick left and right. Adjust the SWcp.AIL rate in the SWASHset Expert menu to be minimize any interaction present similar to those observed for AIL inputs at half collective.
- If the interaction is increased when increasing the SWcp.AIL rate, the compensation direction is reversed. Open the CpA.Dir menu and set the direction to minus.
- Mixing rates for both left and right aileron should be adjusted. Move the collective stick to minimum position. Adjust SWcp.AIL rate the same as was done for maximum collective pitch.

Elevator movement calibration

- Move the collective stick to the center position. Move the elevator stick up and down.
- Adjust the ELE → PIT and/or ELE → AIL mixing rates in the SWASHset Expert menu to minimize any observed interactions. When an UP or DOWN ELE command is input, you may observe an ELE → AIL interaction. You can see this interaction, if present, by precisely positioning the main rotor blades in line with the tail boom. When an ELE command is input, adjust the ELE → AIL mixing rate until the blades do not move. The mixing rates should be adjusted for both up and down directions.
- Move the collective stick to maximum position. Open the SWcp.ELE in the SWASHset Expert menu. Move the elevator stick up and down. Adjust the SWcp.ELE rate in the SWASHset Expert menu to minimize the interaction between ele input and pit and/or ail.
- In case of the interaction is increased when increasing the SWcp.ELE rate, the compensation direction is reversed. Open the CpE.Dir menu and set the direction to minus. Mixing rates for up and down elevator should be adjusted. Move the collective stick to minimum position. Adjust SWcp.ELE rate same as was done for maximum collective pitch.
- Open the SpeedCmp on the SWASHset Expert menu. Move the elevator stick up and down quickly and look for what is best described as a ELE → PIT interaction or "wobble" in the swashplate. The faster your servos, the less the wobble. Adjust the SpeedCmp rate as needed to minimize this interaction.

Expert Gyro and Governor Definitions and Tuning Section

GOVERNOR EXPERT SETTING

This menu sets the details of the governor function for the expert modeler. Push the mode + or – key for more than one second on the Governor Basic menu display, to get into the Governor Expert menu. Push mode + or – key for more than one second again on the Governor Expert menu to be returned to the Governor Basic menu.

GOVERNOR EXPERT MAP 1/2

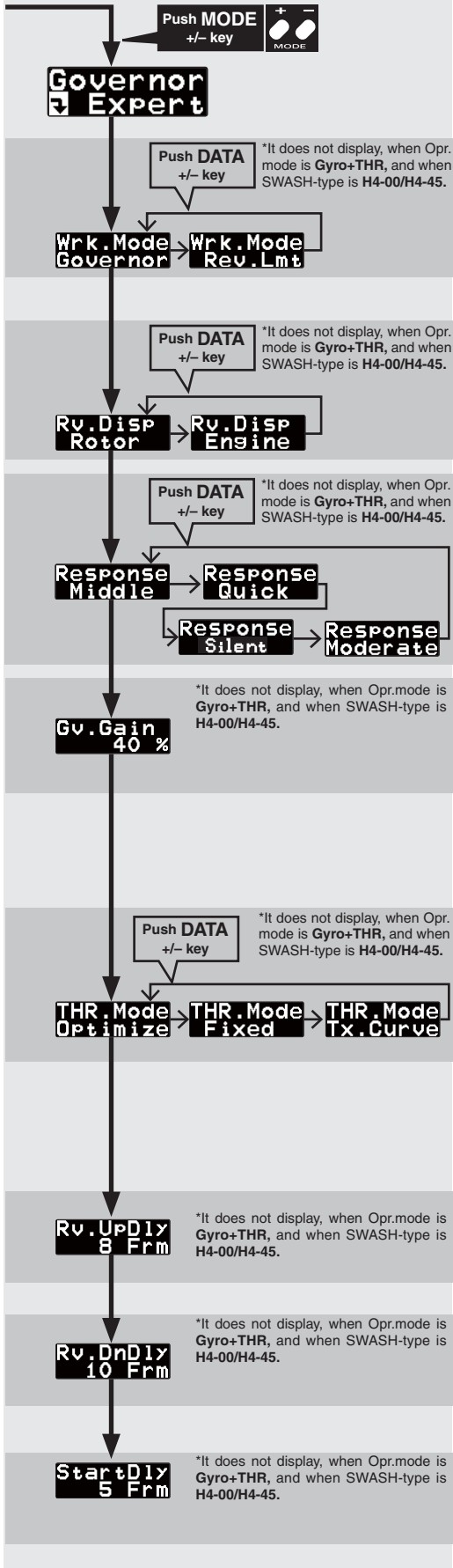

(1) Governor Expert setting: start display

Push mode + or – key, to scroll through the editing menu. Pushing mode + or – key for more than one second, brings you back to governor basic menu.

(2) Governor working mode [default: Governor]

This parameter selects the governor working mode as either governor or revolution limit mode. The governor mode works to actively maintain the engine's revolution is at a constant rate. The revolution limit (Rev. Lmt) mode only works when the engine revolution exceeds the set RPM revolution and engine revolution needs to be reduced. Pushing data+ or – key the mode is changed. When the Rev.Lmt mode is selected, the menu (6) Throttle data mode should be set to Tx.Curve mode.

(3) Revolution display mode [default: Rotor]

This parameter selects the revolution display mode for either the main rotor or engine revolution. By pushing data+ or – key, the mode is changed.

(4) Operation response [default: Middle]

This parameter selects the governor operation response. Select the best match for your engine type. Pushing data+ or – key, the mode is changed. Recommended selection are, Middle → glow engine, Moderate → gasoline engine, Quick → brushless motor, Silent → electric models when RPM detection is accomplished either with a magnet on the motor's rotor or with a brushless phase sensor.

(5) Governor gain [default: Moderate=30%,Middle=40%,Quick=60%] [ranges: 10% ~ 100%]

This parameter sets the governor working gain. When the operation response is changed, the governor gain is automatically changed as default. The best gain percentage is the amount right before engine RPM "hunting" occurs. By pushing the data+ or – key, the value is changed.

(6) Throttle data mode [default: Optimize]

This parameter selects the throttle input operation. Pushing data+ or – key, the mode is changed.

Optimize:

CGY750 sets the throttle input signal to optimum. There is no need to consider the throttle curve setting on the transmitter.

Fixed:

The fixed throttle input is utilized related to the revolution. It is recommended for electric motors.

Tx. Curve:

CGY750 uses the exact throttle input from the transmitter. The throttle curve setting on the transmitter is required. When the Rev.Lmt mode is selected, this mode should be selected.

(7) Revolution change up delay [default: 8] [ranges: 2 ~ 20]

This parameter sets the delay of the rpm change from a lower setting to a higher one. By pushing data+ or – key, the value is changed.

(8) Revolution down delay [default: 10] [ranges: 2 ~ 20]

This parameter sets the delay of the rpm change from higher setting to lower one. By pushing data+ or – key, the value is changed.

(9) Start delay [default: 5] [ranges: 2 ~ 20]

This parameter sets the delay during the starting of the governor. By pushing data+ or – key, the value is changed.

Expert Gyro and Governor Definitions and Tuning Section

GOVERNOR EXPERT SETTING

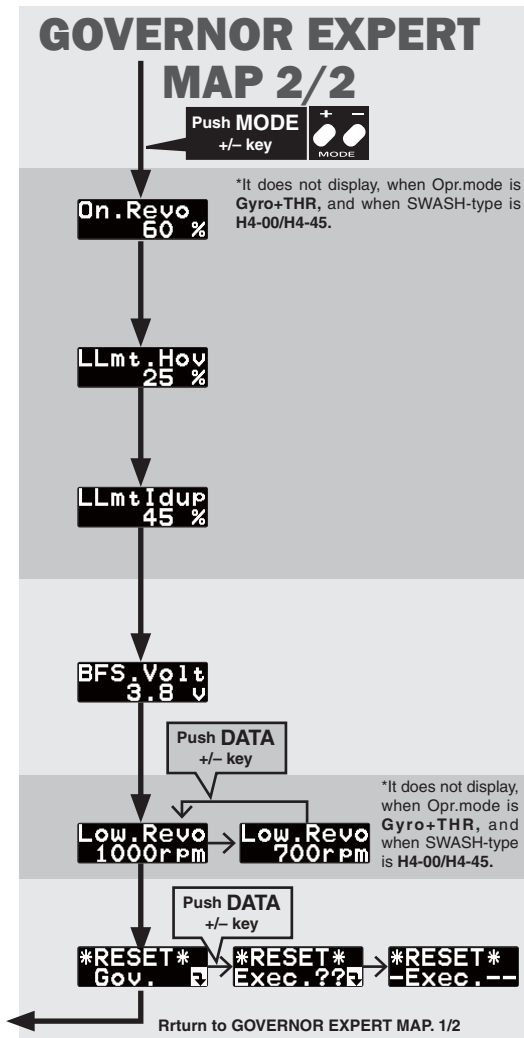

(10) Governor ON revolution setting [default: 60%] [ranges: 50% ~ 90%]

This parameter tells the governor at what percentage of the set rpm it is to become active. The default value is 60 %. In this case, the governor will not engage until the engine rpm reaches 60 % of the set rpm. If you feel that the time for governor engagement is too slow, decrease the value to 50 ~ 55%. The starting time will be faster.

(11) Low limit at hovering [default: 25%] [ranges: 0% ~ 80%]

This parameter sets the governed throttle low limit during hovering rpm to avoid too lean a fuel mixture caused when the governor places the throttle in the typically lean mixture range of about 25%. By pushing data+ or – key, the value is changed.

(12) Low limit at idle up [default: 45%] [ranges: 10% ~ 80%]

This parameter sets the governed throttle low limit during idle up rpm to avoid to avoid the same excessively lean fuel mixture described for (11), above. By pushing data+ or – key, the value is changed. Low limit at idle up is also useful to tune out overspeed or underspeed when the rotor-head is depitched in certain aerobatic maneuvers.

(13) Battery F/S voltage setting [default: 3.8V] [ranges: 3.5V ~ 7.5V]

This parameter sets the battery fail safe and low battery alarm voltage. Set the proper voltage by the battery type. The battery characteristics are different depending on cell type/chemistry. The voltage setting is changed by pushing DATA+ or – key. Suggested setting voltages are as follows.

- 4 cells NiCd or NiMH (Normal: 4.8v) = 3.8 v
- 2 cells LiFe (Normal: 6.6 v) = 6.0 ~ 6.2 v
- 2 cells LiPo (Normal: 7.4 v) = 7.2 ~ 7.4 v

(14) Low revolution setting [default: 1000 rpm]

This parameter sets the minimum revolution setting ranges. The setting can go as low as 700 rpm to accommodate large gasoline powered models.

(15) Governor data reset

This parameter resets also the governor parameters to default settings. The “Exec.??” is displayed by pushing data + or – key for confirmation. Pushing data+ or -key again completes the reset process, displays “-Exec.-”, and returns to the start display. By pushing mode+ or – key during confirmation display, the reset process is aborted.

TIPS FOR USING THE CGY750 GOVERNOR WITH ELECTRIC MODELS

⚠ WARNING

⚠ Safety Reminder: Remove both main and tail blades from the model and/or disengage the motor's pinion from the main gear before proceeding with any electric governor set up.

- Make sure your ESC is configured for external governor use. Refer to the owner's manual for your ESC.
 - You may use either a brushless phase sensor or the traditional governor magnetic sensor with a magnet mounted in a collar on the main shaft or in the main gear. With one magnet, set the gear ratio to 1:1.
 - When choosing a brushless phase sensor, observe the input signal range of the CGY750 specified in the Governor Basic section.
 - Refer to the manufacturer's documentation for your electric motor to select the correct pole count when using a brushless phase sensor. Pole count is set to 2 when using a magnetic sensor.
 - Set the governor Working Mode (Wrk.Mode) to “Governor” (EXPERT Menu).
 - Set the governor Response to “Silent” (Expert Menu).
 - Set the servo type (ServoTyp) to DG:1520.
 - Set Throttle Mode (THR.Mode) to FIXED (Expert Menu).
- NOTE:** It is permissible to experiment with OPTIMIZE as well to obtain the best match between governor, ESC, and motor.
- Make sure you correctly calibrate your ESC.
 - Make sure you calibrate the governor speed ranges in the transmitter's governor menu and set the high and low limits for throttle in the Governor Basic menu.
 - If a tail “kick” or “jerk” is observed when switching from one idle-up headspeed to another, INCREASE the Revolution Up and Down delays (Rv.UpDly/Rv.DnDly – Expert Menu). Increase 2-5% at a time until the tail “kick” is suppressed.
 - The greater the electronic speed control headroom built into the model as a function of its gearing, the more prone the tail will be to kicking with aggressive flying. Models geared for high headspeed but flown aggressively at low headspeed present the greatest challenge for the governor. The more optimally your model is geared for your chosen headspeed, the better the governor will function.
 - Excessive governor gain worsens tail kick. Use as little gain as necessary for adequate headspeed control.
 - If the model yaws nose left with aggressive collective input, activate and adjust the PIT → RUD F/F (feed forward) mixing. Increase in 2-5% increments. F/F mixing should ADD pitch to rudder with added positive or negative collective pitch assuming a CW main rotor direction.

©Copyright 2013. No part of this manual may be reproduced in any form without prior permission. The contents of this manual are subject to change without prior notice. While this manual has been carefully written, there may be inadvertent errors or omissions. Please contact our service center if you feel that any corrections or clarifications should be made.

FUTABA CORPORATION Phone: +81 475 32 6982, Facsimile: +81 475 32 6983
1080 Yabutsuka, Chosei-mura, Chosei-gun, Chiba 299-4395, Japan

©FUTABA CORPORATION 2014, 1 (1)