



# FAI Sporting Code

*Fédération  
Aéronautique  
Internationale*

---

## Section 4 – Aeromodelling

# Volume F3 Radio Control Model Helicopters

2015 Edition

Effective 1st January 2015

F3C – RC HELICOPTERS  
F3N – RC HELICOPTERS FREESTYLE  
ANNEX 5D – F3C MANOEUVRE DESCRIPTIONS & DIAGRAMS  
ANNEX 5E – F3C JUDGES' GUIDE  
ANNEX 5F – F3N MANOEUVRE DESCRIPTIONS & DIAGRAMS  
ANNEX 5G – F3N JUDGES' GUIDE

*Maison du Sport International  
Avenue de Rhodanie 54  
CH-1007 Lausanne  
Switzerland  
Tel: +41(0)21/345.10.70  
Fax: +41(0)21/345.10.77  
Email: [sec@fai.org](mailto:sec@fai.org)  
Web: [www.fai.org](http://www.fai.org)*

**FEDERATION AERONAUTIQUE INTERNATIONALE**  
**MSI - Avenue de Rhodanie 54 – CH-1007 Lausanne – Switzerland**

---

Copyright 2015

All rights reserved. Copyright in this document is owned by the Fédération Aéronautique Internationale (FAI). Any person acting on behalf of the FAI or one of its Members is hereby authorised to copy, print, and distribute this document, subject to the following conditions:

- 1. The document may be used for information only and may not be exploited for commercial purposes.**
- 2. Any copy of this document or portion thereof must include this copyright notice.**
- 3. Regulations applicable to air law, air traffic and control in the respective countries are reserved in any event. They must be observed and, where applicable, take precedence over any sport regulations**

Note that any product, process or technology described in the document may be the subject of other Intellectual Property rights reserved by the Fédération Aéronautique Internationale or other entities and is not licensed hereunder.

# RIGHTS TO FAI INTERNATIONAL SPORTING EVENTS

All international sporting events organised wholly or partly under the rules of the Fédération Aéronautique Internationale (FAI) Sporting Code<sup>1</sup> are termed *FAI International Sporting Events*<sup>2</sup>. Under the FAI Statutes<sup>3</sup>, FAI owns and controls all rights relating to FAI International Sporting Events. FAI Members<sup>4</sup> shall, within their national territories<sup>5</sup>, enforce FAI ownership of FAI International Sporting Events and require them to be registered in the FAI Sporting Calendar<sup>6</sup>.

Permission and authority to exploit any rights to any commercial activity at such events, including but not limited to advertising at or for such events, use of the event name or logo for merchandising purposes and use of any sound and/or image, whether recorded electronically or otherwise or transmitted in real time, must be sought by way of prior agreement with FAI. This includes specifically all rights to the use of any material, electronic or other, that forms part of any method or system for judging, scoring, performance evaluation or information utilised in any FAI International Sporting Event<sup>7</sup>.

Each FAI Air Sport Commission<sup>8</sup> is authorised to negotiate prior agreements on behalf of FAI with FAI Members or other entities as appropriate, of the transfer of all or parts of the rights to any FAI International Sporting Event (except World Air Games events<sup>9</sup>) which is organised wholly or partly under the Sporting Code section<sup>10</sup> for which that Commission is responsible<sup>11</sup>. Any such transfer of rights shall be by "Organiser Agreement"<sup>12</sup> as specified in the current FAI Bylaws Chapter 1, para 1.2 "Rules for Transfer of Rights to FAI International Sporting Events".

Any person or legal entity which accepts the responsibility for organising an FAI Sporting Event, whether or not by written agreement, in doing so also accepts the proprietary rights of FAI as stated above. Where no formal transfer of rights has been established, FAI retains all rights to the event. Regardless of any agreement or transfer of rights, FAI shall have, free of charge for its own archival and/or promotional use, full access to any sound and/or visual images of any FAI Sporting Event, and always reserves itself the right to have any and all parts of any event recorded, filmed and/or photographed for such use, without charge.

---

1 FAI Statutes, Chapter 1, para. 1.6

2 FAI Sporting Code, General Section, Chapter 3, para 3.1.3.

3 FAI Statutes, Chapter 1, para 1.8.1

4 FAI Statutes, Chapter 2, para 2.1.1

5 FAI Bylaws, Chapter 1, para 1.2.1

6 FAI Sporting Code, General Section, Chapter 3, para 3.4

7 FAI Bylaws, Chapter 1, para 1.2.3

8 FAI Statutes, Chapter 5, para 5.2

9 FAI Sporting Code, General Section, Chapter 3, para 3.1.7

10 FAI Sporting Code, General Section, Chapter 1, paras 1.2. and 1.4

11 FAI Statutes, Chapter 5, para 5.2.3.3.7

12 FAI Bylaws, Chapter 1, para 1.2.2

**PAGE DELIBERATELY LEFT BLANK**

# **VOLUME F3 HELICOPTERS**

## **SECTION 4C – MODEL AIRCRAFT – F3 HELICOPTERS**

### **Part Five – Technical Regulations for Radio Controlled Contests**

#### 5.4. F3C Helicopters

Annex 5D – F3C Manoeuvre Description & Diagrams

Annex 5E – F3C Judges' Guide

#### 5.11 F3N Helicopters Freestyle

Annex 5F – F3N Manoeuvre Description & Diagrams

Annex 5G – F3N Judges' Guide

**THIS 2015 EDITION INCLUDES THE FOLLOWING AMENDMENTS MADE TO 2014 CODE**

**These amendments are marked by a double line in the right margin of this edition**

Paragraph	Plenary meeting approving change	Brief description of change	Change incorporated by
5G.8.1	2014	Add text for safety reasons to penalise risky manoeuvres in freestyle flight.	Kevin Dodd Technical Secretary
<b>Annex 5F</b> 5F.3	n/a	Class F3N Optional Manoeuvre List is set annually.	

**Four-Year Rolling Amendments for Reference**

Paragraph	Plenary meeting approving change	Brief description of change	Change incorporated by
<b>F3C 5.4.14</b>	2013	<b>Corrected the schedule's valid years to 2015 - 2015</b>	Jo Halman, Technical Secretary
<b>Annex 5D</b>		<b>Corrected manoeuvre names for F.6 &amp; F.7</b>	
<b>F3C</b>	n/a		Jo Halman, Technical Secretary
<b>Annex 5D</b>			
5D.1		Relocated both instances of the landing scoring reference from the end of the P & F schedules to the end of this paragraph.	
5D.2 - P2		Corrected flag numbers.	Jo Halman, Technical Secretary on behalf of Dag Eckoff, F3 Helicopter S-C Chairman
5D.2 - P4		Clarified regarding altitude	
5D.2 - P5		Clarified note.	
5D.2 - P8		Corrected the manoeuvre title to match the manoeuvre description; clarified note.	
5D.2 - P9		Added missing text.	
5D.3 - F2 & F3		Clarified note.	
5D.3 - F4		Added missing word.	
5D.3 - F5		Corrected the manoeuvre title to match the manoeuvre description; clarified note.	
5D.3 - F6		Corrected the manoeuvre title to match the manoeuvre description.	
5D.3 - F7		Added missing word.	
<b>F3C Annex 5E</b>		Added new "9 – Stall Turns" to bring in line with new manoeuvre descriptions & re-numbered the two subsequent paragraphs.	
<b>F3C</b>			
5.4.3 d)	Replaced the existing paragraph entirely.		
5.4.10	Added a new paragraph e).		
Annex 5D	First paragraph: reduced the flight time to 9 minutes & added new schedules P & F list of manoeuvres.		
5D.2	Added the Schedule P manoeuvre descriptions & diagrams.		
5D.3	Added the Schedule F manoeuvre descriptions & diagrams.		
<b>F3N</b>			
5.11.6	Deleted the restriction on restarting the engine.		
5.11.7	Added a new final paragraph regarding visibility of manoeuvres.		
5.11.9	Clarified when the flight time begins.		
<b>Annex 5F</b>			
5F.1	Deleted the downgrade if the engine is running during auto-rotation.		
1.15; 1.24; 1.29; 1.30.	Replaced manoeuvres. See the new diagrams.		
1.22; 1.23; 1.26; 1.28	Changed the K-factors.		

Four-Year Rolling Amendments .../cont

cont/... Four-year Rolling Amendments for Reference

Paragraph	Plenary meeting approving change	Brief description of change	Change incorporated by
<b>F3C</b>			
5.4.12	2012	Specification of rotation of judges. To prevent conflict with ABR A.11, the Plenary Meeting amendment to change "must" to "may" for the Bureau proposal was not applied in this volume.	Jo Halman, Technical Secretary
5.4.13		Specification of when batteries must be disconnected.	
5.4.14		Models may be flown or carried to the helipad. Paragraph split into sub-paragraphs for clarity.	
Annex 5D, 5D.2 – P10		Clarification of downgrade.	
Annex 5E, 5E.6.3		Clarification of stops.	
<b>F3N</b>			
5.11.5	2012	Clarification of the number of model aircraft permitted.	
5.11.7		Specification of rotation of judges. To prevent conflict with ABR A.11, the Plenary Meeting amendment to change "must" to "may" for the Bureau proposal was not applied in this volume.	
5F.3		Annual changes to the F3N Optional manoeuvres	
5.4.3. c)	2011	F3C Removal of internal combustion engine limitation	Dag Eckhoff S/C Chairman
Annex 5D - 5.D.2, P1, P9		F3C Pirouettes in either direction.	
Annex 5D - 5.D.3, F1, F2, F3		F3C Pirouettes in either direction.	
5.11.3		F3N Shape and distances to be maintained for safety.	
5.11.6		F3N Three flight programmes.	
5.11.7		F3N Clarification of programme flight length.	
5.11.8		F3N Clarification of classification.	
5.11.9		F3N Determining the flight order.	
5.11.10		F3N Safety – touching the ground except on landing, plus definition of Set Manoeuvre Flight, Freestyle Flight & Musical Freestyle Flight.	
5.11.11		F3N Optional Manoeuvres	
Annex 5F		F3N Manoeuvre descriptions with diagrams: 30 Set Manoeuvres plus 10 Optional Manoeuvres of which the latter will be set annually in future.	
Figure 5F.A		F3N Upgraded contest area layout	
Annex 5F		F3N Changed order of manoeuvres; some changed K factors; some amended manoeuvres	
Annex 5G	F3N Judges' Guide		
Page 7	Consequential change to the rule freeze paragraph, re optional manoeuvres.	Technical Secretary	
5.11	Rationalised class name with F3C.		
Annexes 5D, 5E, 5F, FG	F3N Class annexes now appear immediately after the appropriate class.		
5F.1	F3N Added numbering to the first two paragraphs.		
n/a		Corrected English language throughout.	

Four-year Rolling Amendments for Reference cont/...

<b>Four-Year Rolling Amendments for Reference</b>			
<b>Paragraph</b>	<b>Plenary meeting approving change</b>	<b>Brief description of change</b>	<b>Change incorporated by</b>
Rule Freeze	2010	New text to clarify rule change cycles. Consequential change for ABR reference from A.12 to A.13.	Technical Secretary
5.4.3		Driving of tail rotors	
5.11		F3N, official status; consequential changes: new class number and relocated	
Annex 5.F		Consequential change to title: now F3N Manoeuvres and re-numbered	
5.F.3.	n/a	Corrected text from "spreadsheet" to "table"	
5.4.3	n/a	Corrected formatting to first paragraph and numbered	

### **RULE FREEZE FOR THIS VOLUME**

With reference to paragraph A.13 of Volume ABR:

In all classes, the two-year rule for no changes to model aircraft/space model specifications, manoeuvre schedules and competition rules will be strictly enforced. For Championship classes, changes may be proposed in the year of the World Championship of each category.

For official classes without Championship status, the two-year cycle begins in the year that the Plenary Meeting approved the official status of the class. For official classes, changes may be proposed in the second year of the two-year cycle.

This means that in Volume F3 Helicopters:

- (a) changes for F3C and F3N can next be agreed at the Plenary meeting 2015 for application from January 2016; note that F3N optional manoeuvres are set annually and approved by CIAM Bureau.
- (b) provisional classes are not subject to this restriction.

The only exceptions allowed to the two-year rule freeze are genuine and urgent safety matters, indispensable rule clarifications and noise rulings.



## VOLUME F3 HELICOPTERS

### PART FIVE - TECHNICAL REGULATIONS FOR RADIO CONTROLLED CONTESTS

#### 5.4. CLASS F3C HELICOPTERS

##### 5.4.1. Definition of a Radio Controlled (R/C) Helicopter

An R/C helicopter is a heavier-than-air model aircraft (MA) that derives all of its lift and horizontal propulsion from a power driven rotor system(s) rotating about a nominally vertical axis (or axes). Fixed horizontal supporting surfaces up to 4% of the swept area of the lifting rotor(s) are permitted. A fixed or controllable horizontal stabiliser of up to 2% of the swept area of the lifting rotor(s) is permitted. Ground effect machines (hovercraft), convertiplanes or aircraft that hover by means of propeller slipstream(s) deflected downward are not considered to be helicopters.

##### 5.4.2. Builder of the Model Aircraft

Paragraph B.3.1.a) of Section 4b (Builder of the model aircraft) is not applicable to class F3C.

##### 5.4.3. General Characteristics

- a) AREA: The swept area of the lifting rotor cannot exceed 250dm<sup>2</sup>. For helicopters with multiple rotors whose rotor shafts are more than one rotor diameter apart the total swept area of both rotors cannot exceed 250dm<sup>2</sup>. For helicopters with multiple rotors whose rotor shafts are less than one rotor diameter apart the swept area of both rotors (counting the area of superposition only once) cannot exceed 250dm<sup>2</sup>. The tail rotor must be driven by the main rotor and must not be driven by a separate engine/motor.
- b) WEIGHT: The weight of the model aircraft (with fuel / with batteries) must not exceed 6.5 kg.
- c) MOTOR: Internal combustion engine displacement: no restrictions.  
Electric motors are limited to a maximum no load voltage of 51 volts for the propulsion circuit.
- d) GYROS: The use of pre-programmed flight manoeuvres is forbidden. The use of automatic position (latitude and longitude) locking devices and altitude locking devices, whether with external references or not, are forbidden.
- e) ROTOR BLADES: All-metal main or tail rotor blades are prohibited.

##### 5.4.4. Noise Limit

Noise level measurements must be made before the start of a competition, preferably during the official practice day. The noise level must be measured at a distance of 3m (3 metres) while the helicopter is hovering with the skids/landing gear at 2m over the centre of a 2m diameter circle. A remote microphone mounted on a tripod must be used. The engine speed (RPM) must be the same as that used during the hovering portion of the flight schedules. During the measurement the helicopter must be rotated through 360° to determine the maximum noise level. The sound pressure level must not exceed 87dB (A) over a soft (grass) surface or 89dB (A) over a hard (asphalt, concrete, etc) surface. If the noise level limit is exceeded during the first measurement, two additional measurements must be made to substantiate the excessive noise level. The competitor may modify the helicopter and/or silencer system to reduce the noise level and after verification of an acceptable level, will be permitted to fly. If the noise level cannot be reduced to or below the noise level limit it will not be allowed to fly in the competition. The measuring equipment must be calibrated to the dB (A) sound pressure level scale defined in applicable ISO Standards. If noise measuring equipment that can be calibrated to ISO Standards is not available, the measurements will be advisory only and no competitor can be excluded from the competition.

##### 5.4.5. Contest Area Layout

See FIGURE 5.4.A. Note: If two flight lines are used they must be parallel, operate simultaneously, face in the same direction and be separated by a minimum of 500m for a "front-to-back configuration" or a minimum of 1000m for a side-by-side configuration.

##### 5.4.6. Number of Helpers

Each competitor is allowed only one mechanic/caller. The mechanic/caller must announce the start, finish and name or number of each manoeuvre, and should inform the pilot of wind direction, remaining flight time, proximity to prohibited areas and intrusions into the flight area. Team managers may observe the flight from a position 5m behind the judges and away from the start circle. Team managers may serve as mechanic/caller if no separate person is available for this task.

**5.4.7. Number of Model Aircraft**

The number of model aircraft eligible for entry is two (2). Model aircraft numbers 1 and 2 may only be exchanged within the start circle. Both model aircraft must use the same radio frequency.

**5.4.8. Number of Flights**

At Continental and World Championships, each competitor is entitled to four (4) official preliminary flights. After completion of the preliminary flights the top 15 are entitled to three fly-off flights. At national and open International Competitions the preliminary/fly-off system is not mandatory.

**5.4.9. Definition of an Official Flight**

There is an official flight when the competitor is officially called. The flight may be repeated if, for any unforeseen reason outside the control of the competitor, the model aircraft fails to make a start such as:

- a) The flight cannot safely be made within the allowed time limit.
- b) The competitor can prove that the flight was hindered by outside interference.
- c) Judging was impossible for reasons beyond the control of the competitor (model aircraft, engine, or radio failures are not considered to be outside the control of the competitor). In such cases the flight **shall** be repeated as close to the published time as possible. The competitor, however, has the right to refuse a reflight.

**5.4.10. Scoring**

Each manoeuvre is given a score between 0 and 10 (including half) points by each judge. A new score sheet is issued to each competitor for each round. Only the competitor's number (no name or nationality) will appear on the score sheet. Any manoeuvre not completed shall be scored zero (0) points. If a manoeuvre is scored zero points all judges must agree. There shall be an official located on the field where any flight over the prohibited area can be observed. The prohibited area is the shaded area in Figure 5.4.A behind the judges' line. The area extends to infinity to the left, right and rear. A visual or audible signal shall be given to indicate such over flights. Competitors flying over this area will be penalised by scoring zero (0) points for the current flight. However, the judges shall score all manoeuvres. If an infringement has been made, the scores will be deleted from all score sheets after the flight. In addition, there shall be no score when:

- a) The competitor flies a model aircraft that has been flown in the same competition by another competitor, or flies a model aircraft that does not comply with the definition and general characteristics of a radio controlled helicopter.
- b) The competitor does not deliver his transmitter to the impound or operates any transmitter at the competition area during a round without permission.
- c) The competitor starts his model aircraft outside of the start circle.
- d) The competitor gets his transmitter from the impound before he is officially called.
- e) Manoeuvres must be performed where they can be seen clearly by the judges. If a judge, for some reason beyond the control of the competitor, is not able to follow the model aircraft through the entire manoeuvre, he may put a "Not Observed" (N.O.) mark. In this case, his score will, for that particular manoeuvre, be set to the average score given by the other judges, rounded to the nearest half point.

**5.4.11. Classification**

After the completion of four official (preliminary) rounds, the best three scores will be used to determine the placings. The top 15 of all competitors then compete in three fly-off rounds to determine the final individual classification. The results of the best three preliminary rounds (normalised to 1000 points) will count as one score. This score, plus the three fly-off scores, provide four scores with the best three to count for the final individual classification. The fly-offs to determine the individual classification are only required for World and Continental Championships.

If the competition is interrupted during the preliminary rounds, the final individual classification will be determined by counting all completed preliminary rounds and dropping the lowest. If the competition is interrupted during the fly-off rounds, the final individual classification will be determined by counting all completed fly-off rounds plus the results from the preliminary rounds and dropping the lowest.

All scores for each round will be normalised by awarding 1000 points to the highest scoring flight. The remaining scores are then normalised to a percentage of the 1000 points in the ratio of actual score over the score of the winner of the round. If only one round is possible then the classification will be based on that one round.

*cont/...*

For example:

$\text{Points}_{(X)} = \text{Score}_{(X)} \text{ divided by } \text{Score}_{(W)} \text{ multiplied by } 1000$

Where  $\text{Points}_{(X)} = \text{Points awarded to competitor X}$

$\text{Score}_{(X)} = \text{Score of competitor X}$

$\text{Score}_{(W)} = \text{Score of winner of the round}$

Ties for any of the first three places will be broken by counting the highest throwaway score. If the tie still stands a "sudden death" fly-off must take place within one hour of the end of the scheduled fly-off rounds.

The team classification for World and Continental Championships is established at the end of the competition (after the fly-off flights) by adding the numerical final placing of the three team members of each nation. Teams are ranked from the lowest numerical scores to the highest, with complete three-competitor teams ahead of two-competitor teams, which in turn are ranked ahead of one-competitor teams. In case of a tie, the best individual placing decides the team ranking.

#### 5.4.12. Judging

At Continental and World Championships the organiser must appoint a panel of five judges for each round/flight line. When the entry exceeds 55, two flight lines must be used. The judges must be of different nationalities and must be selected from the current CIAM list of international judges. When using two separate panels, the organiser is allowed to use two judges of the same nationality, one on each panel. Those selected must reflect the approximate geographical distribution of teams participating in the previous World Championship with the final list approval by the CIAM Bureau. At least 20% but not more than 40% of the judges must not have judged at the previous World Championships.

For the preliminary rounds the final score of each flight is obtained by deleting the highest and lowest scores for each manoeuvre from the five judges. For the fly-off rounds ten judges shall be used while dropping the two lowest and two highest scores for each manoeuvre. At open or other International Competitions the number of judges may be reduced to a minimum of three with no throwaway scores.

- a) There shall be training flights for judges with a debriefing session immediately before a Continental or World Championships.
- b) The scoring system must be organised in such a way that the competitors and the spectators can clearly see the scores awarded by all judges after each flight. The score sheet notation must be written by the judges themselves.

#### 5.4.13. Organisation

TRANSMITTER & FREQUENCY CONTROL (See VOLUME ABR, Section 4B, Paragraph B.11.2). When all transmitters are of the spread spectrum type a transmitter impound is not required.

##### FLIGHT ORDER

The flight order for the first preliminary round will be determined by a random draw, taking into account that frequency will not follow frequency and team member will not follow team member of the same team. The flight order for preliminary rounds two, three and four will start at the first, second and third quarter of the initial order. The flight order for the first fly-off round will be established by a random draw. The flight order for the second and third fly-off rounds will start at the first and second third of the initial order.

##### PREPARATION TIME

A competitor must be called at least 5 minutes before he is required to enter the start circle. A start circle 2m in diameter will be provided away from the flight line, spectators, competitors and model aircraft (see FIGURE 5.4.A). When the previous competitor's flight time reaches 6 minutes the flight line director can give the signal to start the engine. In the case of electric motors, the battery must not be connected before signal has been given. The competitor is given 5 minutes to start the engine and make last minute adjustments. The model aircraft may only be hovered in the start circle up to 2m and must not be rotated beyond 180° left or right relative to the competitor. If the model aircraft is rotated beyond 180° the flight is terminated. The competitor in the start circle must reduce his engine's speed to an idle when the preceding competitor has completed the eighth manoeuvre. If the competitor is not ready after the 5 minute preparation time, he is allowed to complete his adjustments in the start circle; however, his flight time will have started at the end of the 5 minute interval.

*cont/...*

#### FLIGHT TIME

The flight time of 9 minutes begins when the competitor's model leaves the start circle with the permission of the flight line director and the judges. If the allotted time expires before a manoeuvre is completed, that manoeuvre and all remaining manoeuvre(s) will be scored zero.

#### RESTRICTIONS

After starting the model aircraft in the start circle the model aircraft must be flown at 2m to the helipad along the model entry path shown on the Contest Area Layout (Figure 5.4.A). The pilot may test hover the helicopter on the helipad and reposition it, before announcing the start of the first manoeuvre, to accommodate wind conditions. If the engine stops the flight is terminated.

After the flight: In case of electric motors, the battery must be disconnected before the pilot brings the helicopter over the judging line.

#### INTERRUPTION OF A COMPETITION

If the wind component perpendicular to the flight line exceeds 8ms/s for a minimum of 20 seconds during a flight, the competition must be interrupted. The flight will be repeated and the competition continued as soon as the wind subsides below the criterion. If the wind does not subside before the round is completed, the entire round will be dropped. The determination will be made by the organiser with concurrence of the FAI Jury.

### 5.4.14. Manoeuvre Schedules

#### FLIGHT PROGRAM

The flight program consists of manoeuvre schedules P and F for the years 2014 - 2015. Each schedule consists of nine (9) manoeuvres (see ANNEX 5D - F3C MANOEUVRE DESCRIPTIONS).

#### PERFORMANCE OF THE SCHEDULES

The competitor must stand in the 2m circle (labelled P in Figure 5.4.A - F3C Contest Area Layout) located 6m in front of the centre judge. Before the start of the first manoeuvre the pilot may fly or carry the model to the helipad. If the model is flown to the helipad then it must be flown at a height of 2 m (for safety reasons.) Alternatively, the helper may carry the model aircraft to the helipad.

The model aircraft may face left or right but must be parallel with the judges' line.

Each hovering manoeuvre ends with a landing on the helipad and after each landing the model aircraft may be repositioned (but maintains same direction) prior to the next takeoff. After completing the hovering manoeuvres the competitor is allowed one free pass to set up for the flying sequence.

All aerobatics manoeuvres must be performed in an airspace that will allow them to be clearly seen by the judges. This airspace is defined by a field of view up to 60° above the horizon and between lines 60° to the right and left of judges 1 and 5. The non-observance of this rule will be penalised by a loss of points.

The aerobatics manoeuvres must be performed in a smooth flowing sequence, with a manoeuvre performed on each pass before the judges. There are no restrictions on turnaround manoeuvres.

The competitor must perform each listed manoeuvre only once during a flight. The competitor or his caller must announce the name (number) and start and finish of each manoeuvre. A manoeuvre performed out of sequence will result in a zero score for that manoeuvre only. Before the autorotation manoeuvre the competitor is allowed another free pass to accommodate a possible change in wind direction.

### 5.4.15. Manoeuvre Descriptions and Diagrams

Refer to ANNEX 5D

### 5.4.16. Judges' Guide

Refer to ANNEX 5E

**FIGURE 5.4.A - F3C CONTEST AREA LAYOUT**

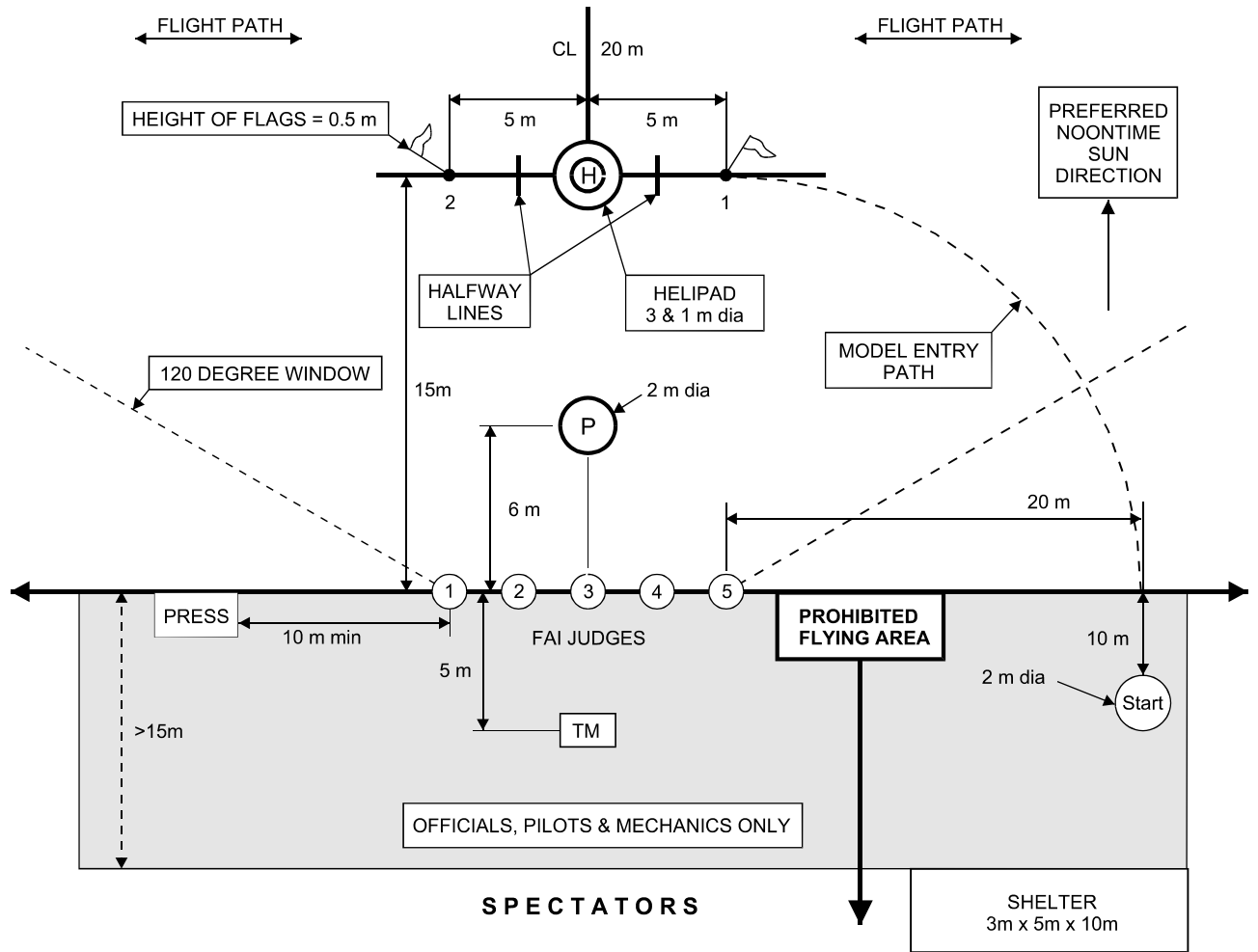

**PAGE DELIBERATELY LEFT BLANK**

**ANNEX 5D****F3C MANOEUVRE DESCRIPTIONS AND DIAGRAMS**

The manoeuvre schedules are listed below with the starting and ending direction (UU = Upwind - Upwind; DD = Downwind - Downwind; DU = Downwind - Upwind; UD = Upwind - Downwind) of each manoeuvre, relative to the wind, as indicated. The competitor has 9 minutes to complete each schedule. Schedule P will be flown for the preliminary rounds 1 through 4. Schedule F will be flown for the Fly-Off rounds.

**SCHEDULE P**

P1. TRIANGLE 1 .....	(UU)
P2. FLOWER.....	(UU)
(FLY BY)	
P3. CANDLE WITH DESCENDING FLIP.....	(DD)
P4. PULLBACK WITH 3 HALF LOOPS .....	(UU)
P5. UX.....	(DD)
P6. OVAL WITH TRAVELLING FLIP .....	(UU)
P7. OPPOSITE TWO ROLLS .....	(DD)
P8. DOUBLE STALL TURNS.....	(UU)
(FLY BY)	
P9. AUTOROTATION WITH TWO 90° TURNS .....	(DU)

**SCHEDULE F**

F1. UMBRELLA.....	(UU)
F2. CONTINUOUS PIROUETTING TRIANGLE .....	(UU)
(FLY BY)	
F3. DOUBLE CANDLE WITH DESCENDING FLIP .....	(DD)
F4. W.....	(UU)
F5. DOUBLE STALL TURN and FLIP.....	(DD)
F6. X .....	(UU)
F7. OPPOSITE HALF AND FULL INVERTED ROLLS.....	(DD)
F8. LOOP WITH FLIP.....	(UU)
(FLY BY)	
F9. AUTOROTATION WITH LOOP .....	(DU)

**5D.1 General**

The manoeuvres are displayed in pictorial form in Figures 5D-P and 5D-F for the case where the wind direction is left to right. The following descriptions apply to all manoeuvres and if not performed properly must result in downgrades. Points will also be subtracted if a manoeuvre is not performed as described. The starting/ending altitude for the hovering manoeuvres is 2m above the helipad. If a manoeuvre is unrecognisable it must be severely downgraded. If pirouettes are performed in the wrong direction, the score shall be zero (0) points. Ascents from, and descents to, the helipad must be vertical. Landings must be smooth and centred on the helipad. During the hovering manoeuvres all stops must be of 2 seconds minimum duration (unless specified otherwise). Circular and linear hovering segments must be performed at a constant speed. Every pirouette must be performed at a constant turning rate. The hovering manoeuvres must be started with the nose of the model aircraft (MA) facing left or right and must be flown as a unit (the starting heading must be same for each hovering manoeuvre). The competitor must stand in the 2m diameter circle marked "P" in Figure 5.4.A during all manoeuvres. All aerobatic manoeuvres must start and end in the direction indicated with a straight and level flight line of 10m minimum length. Entry and exit must be at the same altitude and heading. Loops or parts of a loop must be round and have the same diameter. Consecutive loops must be in the same location and plane. Rolls must be performed at a constant roll rate. Consecutive rolls must have the same roll rate and must be at the same altitude and heading. During all aerobatics manoeuvres the competitor must maintain his MA above a minimum altitude of 10 m. Aerobatic manoeuvres must be centred within the 120° horizontal field of view and must be symmetrical about the centre line. Aerobatic manoeuvres flown at a distance greater than 100m from the judges' line will be downgraded. In case of a dispute the manoeuvre text takes precedence over Figures 5D-P and 5D-F.

Note: When the word "centred" is used, it means that the MA crosses an imaginary plane that extends from a line drawn vertically upward, from the centre judge out through the helipad. This refers to both Schedules P and F.

Scoring criteria for landing; See ANNEX 5E paragraph 5E.6.10.

**5D.2 SCHEDULE P****P1: Triangle 1 (UU)****K Factor  
1.5**

MA takes off vertically from the helipad and ascends to 2m and  
 hovers for a minimum of 2 seconds  
 flies backwards to flag 1 (2) and stops  
 hovers for a minimum of 2 seconds  
 ascends at 45° while simultaneously performing a 180° pirouette in either direction and  
 stops over the helipad  
 hovers for a minimum of 2 seconds  
 performs a 360° pirouette in either direction  
 hovers for a minimum of 2 seconds  
 descends at 45° while simultaneously performing a 180° pirouette in either direction and  
 stops over flag 2 (1)  
 hovers for a minimum of 2 seconds  
 flies backwards and stops over the helipad  
 hovers for a minimum of 2 seconds  
 descends and lands in the helipad

**P2: Flower (UU)****1.5**

MA take off vertically from the helipad and ascends to 2m and  
 hovers for a minimum of 2 seconds  
 ascend backwards while performing a quarter of a 5m radius circle and stops over flag 1 (2)  
 hovers for a minimum of 2 seconds  
 performs half of a 5m radius circle while simultaneously performing a full 360° pirouette and  
 stops over flag 2 (1)  
 hovers for a minimum of 2 seconds  
 descends backwards while performing a quarter of a 5m radius circle and stops over the helipad  
 hovers for a minimum of 2 seconds  
 descends and lands in the helipad

**P3: Candle with descending flip (DD)****None**

MA flies straight and level for a minimum of 10m and  
 pulls up in a centred vertical ascent  
 after coming to a stop, MA flies vertically backwards for a minimum of 2m  
 performs a half pulled travelling flip  
 descends vertically for a minimum of 2m  
 MA pulls into horizontal straight and level flight for a minimum of 10m

Note: Vertical ascent and descent paths must be identical

**P4: Pullback with 3 half loops (UU)****None**

MA flies straight and level for a minimum of 10m and  
 pulls up into a vertical ascent  
 after coming to a stop, MA performs a half backward loop  
 after a vertical tail up, stop, MA performs a centred inverted half loop  
 after a vertical nose up, stop, MA performs a half backward loop  
 after a vertical tail up, stop, MA performs a vertical descent  
 MA pulls into horizontal straight and level flight for a minimum of 10m at the same  
 altitude as entered.

Note: The 3 half loops must be of the same radius & altitude.



**P5: UX (DD)**

MA flies straight and level for a minimum of 10m and  
 pulls up into a 45° ascent with a centred half roll  
 once the MA has come to a stop, MA performs a 135° pulled flip  
 performs a centred 'U', stop  
 performs a 135° pulled flip  
 performs a 45° descent with a centred half roll  
 MA pulls into horizontal straight and level flight for a minimum of 10m  
 Note: The bottom of the 'U' and the rolls must be centred.

**P6: Oval with travelling flip (UU)****None**

MA flies straight and level for a minimum of 10m and  
 pulls up into a half loop  
 flies inverted for a minimum of 1 second  
 performs a travelling 360° centred pushed flip  
 flies inverted for a minimum of 1 second  
 performs a half loop  
 MA pulls into horizontal straight and level flight for a minimum of 10m

**P7: Opposite rolls (DD)****None**

MA flies straight and level for a minimum of 10m and  
 performs a full roll in either direction  
 immediately performs a full roll in the opposite direction  
 MA flies straight and level for a minimum of 10m  
 Note: The middle of the manoeuvre must be centred.

**P8: Double stall turns (UU)****None**

MA flies straight and level for a minimum of 10m and  
 pulls up into a vertical ascent with a stall turn at the apex  
 performs a vertical descent  
 performs a half outside loop  
 performs a vertical ascent with a stall turn at the apex  
 performs a vertical descent  
 MA pulls into horizontal straight and level flight for a minimum of 10m  
 Note 1: The lowest part of the outside loop must be centred and at the same altitude as the entry and exit phases.  
 Note 2: The 2 stall turns must be of the same altitude.

**P9: Autorotation with two 90° Turns (DU)****None**

MA enters the manoeuvre in the autorotation state and must be called before it crosses the centre line and  
 performs 1/3 of the total descent, engine off or at idle, 10m minimum  
 90° turn  
 performs 1/3 of the total descent, engine off or at idle, 10m minimum  
 90° turn  
 MA lands on helipad  
 Note 1: Manoeuvre begins when MA is centred.  
 Note 2: MA must be in an auto rotational state when the manoeuvre begins.  
 Note 3: The descent rate must be constant from the start of the manoeuvre to just before landing in the helipad.  
 Note 4: The flight path of the MA must appear as an open square when viewed from above.

**5D.3 SCHEDULE F****K Factor****F1: Umbrella (UU)****1.5**

MA takes off vertically from the helipad and ascends to 2m and  
 hovers 2 seconds minimum  
 performs a half 2,5m radius circle while performing a 180° nose in pirouette and  
 stops over flag 1 (2)  
 hovers 2 seconds minimum  
 performs a half 5m radius circle while performing a 360° pirouette in either direction and  
 stops over flag 2 (1)  
 hovers 2 seconds minimum  
 performs a half 2,5m radius circle while performing a 180° nose in pirouette and stops  
 over helipad  
 hovers 2 seconds minimum  
 descends to helipad and lands

**F2: Continuous pirouetting triangle (UU)****K=1,5**

MA takes off vertically from the helipad and ascends to 2m and  
 hovers 2 seconds minimum  
 flies backward to flag 1 (2) while performing a 180° pirouette and stops  
 immediately performs a stationary 180° pirouette over flag 1 (2)  
 immediately ascends at 45° while performing a 180° pirouette until the vertical of  
 the helipad  
 immediately descends at 45° while performing a 180° pirouette and stops over  
 flag 2 (1)  
 immediately performs a 180° pirouette over flag 2 (1).  
 immediately flies to the helipad while performing a 180° pirouette and stops over  
 helipad  
 hovers 2 seconds minimum  
 descends to helipad and lands

Note 1: The pirouetting must be continuous in one direction and at a constant rate  
 during the whole manoeuvre. No stop of the pirouetting is allowed.

Note 2: Consequence of Note 1, the translation speed of the MA is not the same during  
 the whole manoeuvre.

**F3: Double candle with descending flip (DD)****None**

MA flies straight and level for a minimum of 10m and  
 pulls up into a vertical ascent  
 after a nose up stop, MA flies backwards vertically for 2m minimum  
 performs a half pulled travelling flip  
 descends vertically for a minimum of 2m  
 performs a centred half loop  
 ascends vertically  
 after a nose up stop, MA flies backwards vertically for 2m minimum  
 performs a half pulled travelling flip  
 descends vertically for 2m minimum  
 MA pulls into horizontal straight and level flight for a minimum of 10m

Note: The 2 flips must be made at the same altitude.

**F4: W (UU)**

MA flies straight and level for a minimum of 10m and  
 pulls up into a vertical ascent with a 540° tail turn at apex  
 performs a vertical descent  
 performs a half loop  
 performs a centred vertical ascent with a half pulled flip at apex  
 performs a centred vertical descent  
 performs a half loop  
 performs a vertical ascent with a 540° tail turn at apex  
 performs a vertical descend

MA pulls into horizontal straight and level flight for a minimum of 10m

Note 1: the radius and the altitude of the two half loops must be the same.

Note 2: the altitude of the 3 apexes must be the same.

**F5: Double stall turn and flip (DD)****None**

MA flies straight and level for a minimum of 10m and  
 pulls up into a ¼ loop  
 performs a centred vertical ascent with a stall turn at apex  
 performs a centred vertical descent  
 performs 3/4 of loop  
 performs 1 centred pushed translated flip  
 performs 3/4 of loop  
 performs a centred vertical ascent with a stall turn at apex  
 performs a centred vertical descent  
 performs 1/4 of loop into horizontal straight and level flight for a minimum of 10m

Note 1: the radius and altitude of all the looping portions must be the same.

Note 2: the centred flip is not necessary performed immediately after the 3/4 loop.

**F6: X (UU)****None**

MA flies straight and level for a minimum of 10m and  
 Pulls up into a 45° ascent with a centred half roll.  
 when MA stops, it performs a centred, horizontal 3/4 transitional pushed flip  
 performs a 45° descend with a centred half roll.  
 MA pulls into horizontal straight and level flight for a minimum of 10m  
 Note: the bottom of the triangle must be centred.

**F7: Opposite half and full inverted rolls (DD)****None**

MA flies straight and level for a minimum of 10m and  
 performs a half roll in either direction  
 Flies inverted for a minimum of 1 second  
 performs a full centred inverted roll in the opposite direction  
 Flies inverted for a minimum of 1 second  
 performs a half roll in the same direction as the first half roll  
 MA flies straight and level flight for a minimum of 10m

*cont/...*

**K Factor**  
**None**

**F8: Loop with flip (UU)**

MA flies straight and level for a minimum of 10m and  
pulls up into a full centred loop with a full centred transitional pulled flip on top  
MA pulls into horizontal straight and level flight for a minimum of 10m

Note 1: The flip trajectory must be included in the loop path.

Note 2: The flip must be  $\frac{1}{4}$  of the loops trajectory.

**F9: Autorotation with loop (DU)**

**None**

MA flies straight and level for a minimum of 10m and  
performs a centred loop and cuts the engine (or at idle) at the top of the loop  
completes the loop with the engine off (or at idle)  
enters a descending 180° turn toward the pilot and land upwind

Note 1: An excessively high entry level will be 1 point downgraded.

Note 2: The descent rate must be constant from the end of the loop to a point just before touchdown on the helipad.

Note 3: The flight path of the MA must appear as a half circle when viewed from above.

*Note: Manoeuvre diagrams are overleaf.*

FIGURE 5D-P: F3C MANOEUVRE SCHEDULE P

P1. Triangle 1

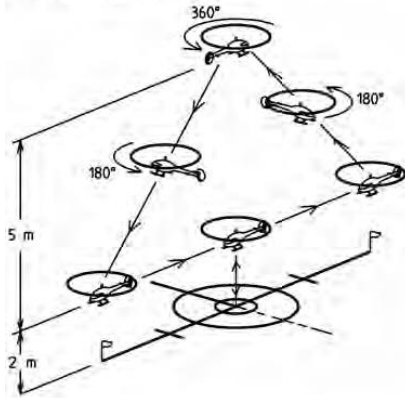

P2. Flower

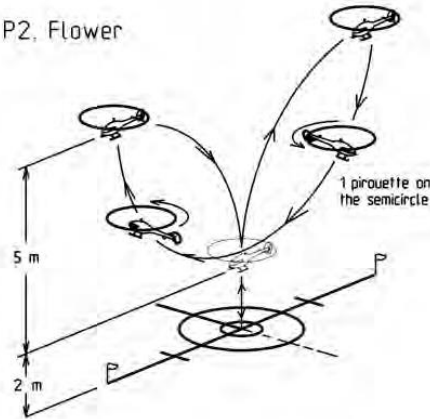

P3. Candle with descending flip

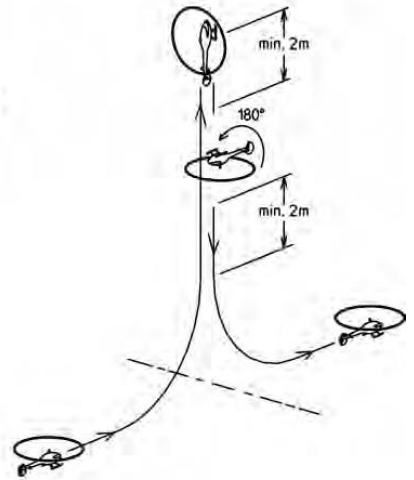

P4. Pullback with 3 half loops

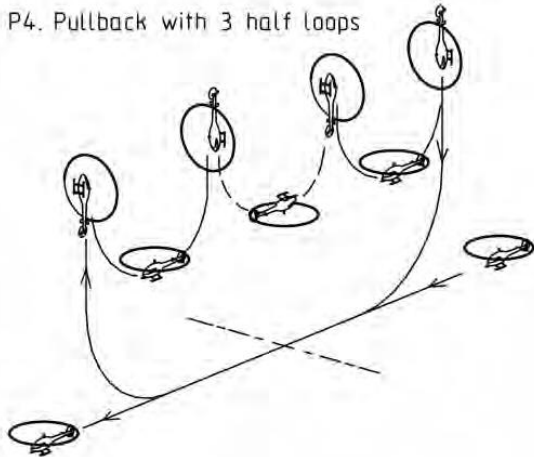

P5. UX

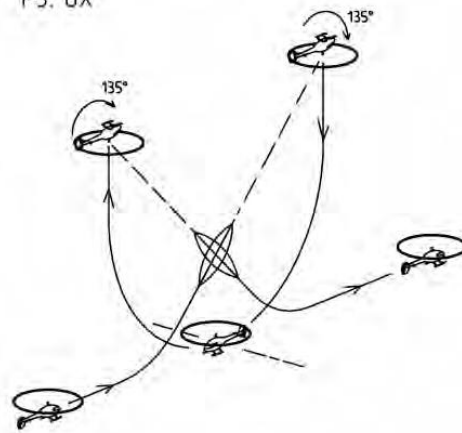

P6. Oval with travelling flip

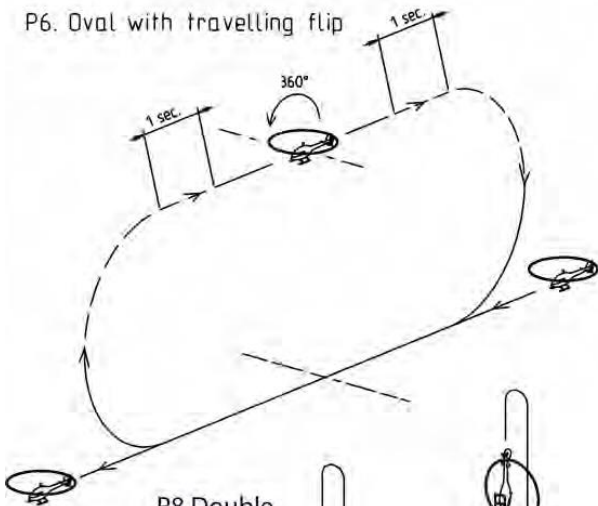

P7. Opposite rolls

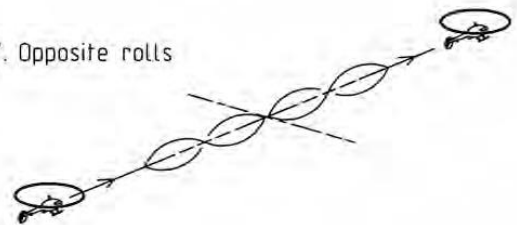

P8 Double stall turn

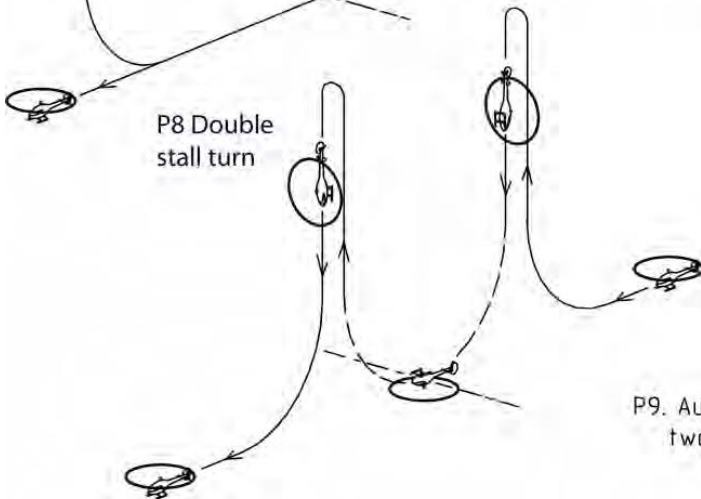

P9. Autorotation with two 90° turns

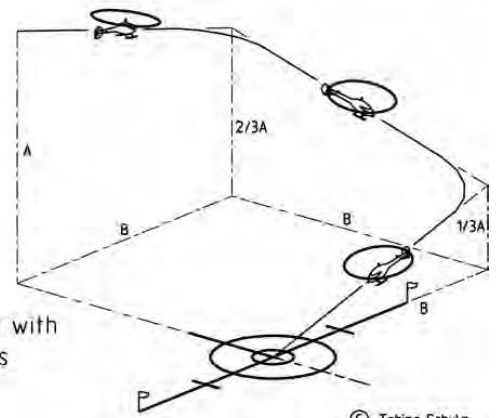

© Tobias Schutz

FIGURE 5D-F: F3C MANOEUVRE SCHEDULE F

F1. Umbrella

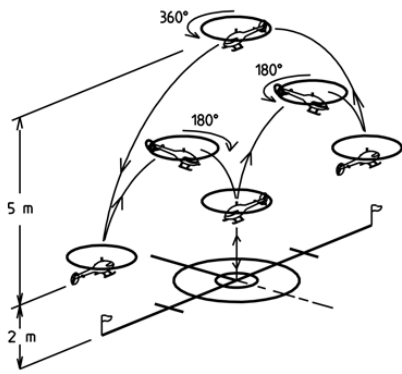

F2. Continuous pirouetting triangle

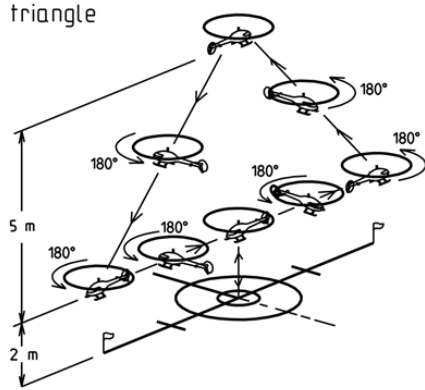

F3. Double candle with descending flip

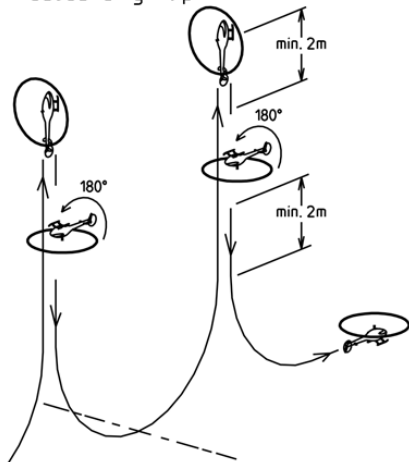

F4. W

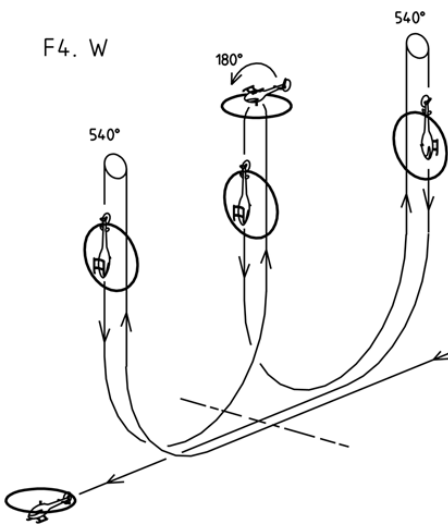

F5 Double stall turn and flip

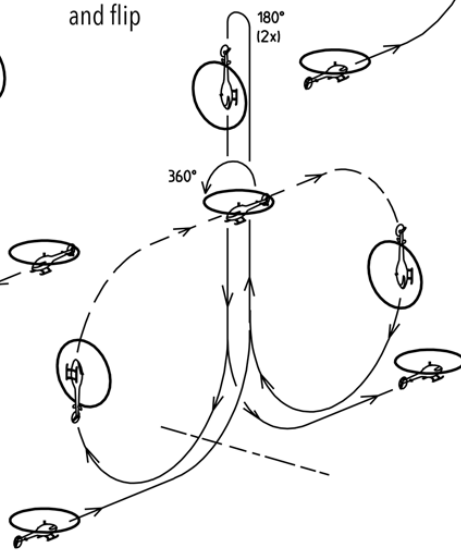

F6. X

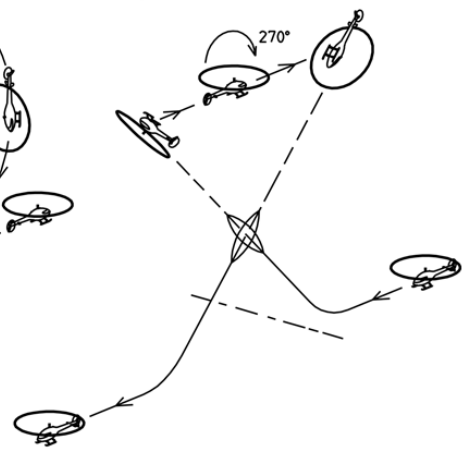

F7. Opposite half and full inverted rolls

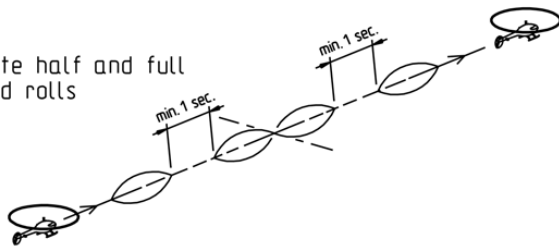

F8. Loop with flip

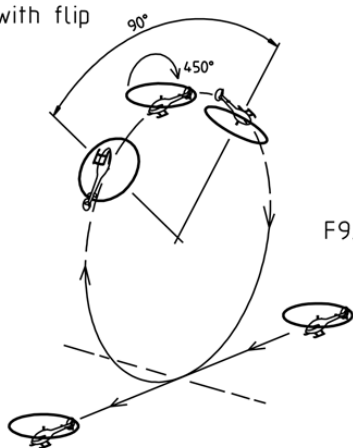

F9. Autorotation with loop

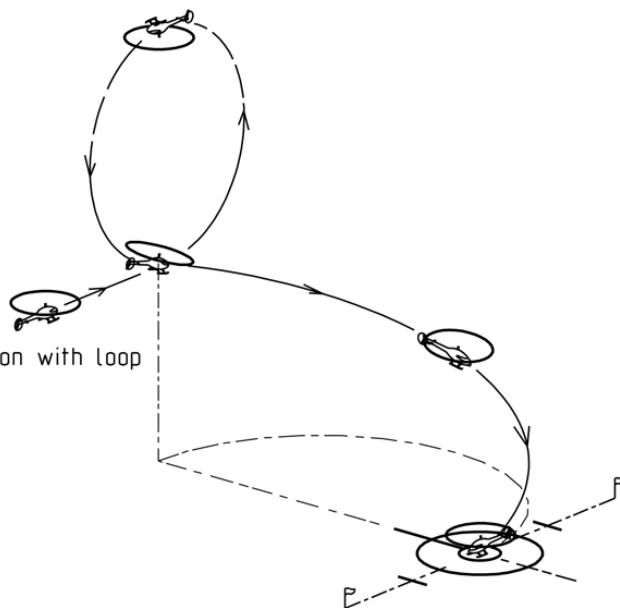

## **ANNEX 5E**

### **F3C JUDGES' GUIDE**

#### **5E.1 PURPOSE**

The purpose of the F3C Judges' Guide is to provide an accurate description of the major judging criteria to serve as a reference for use in developing a uniformly high standard of judging.

#### **5E.2 PRINCIPLES**

The principles of judging a radio controlled model helicopter should be based on the perfection with which the MA performs each manoeuvre as described in Annex 5D.

The main principles used to judge the degree of perfection are:

- 1) Precision of the manoeuvre.
- 2) Smoothness and gracefulness of the manoeuvre.
- 3) Positioning or display of the manoeuvre.
- 4) Size of the manoeuvres relative to each other.

The requirements are listed in order of importance; however, all of them must be met for a manoeuvre to receive a high score.

#### **5E.3 ACCURATE AND CONSISTENT JUDGING**

The most important aspect of judging is consistency. Each judge must establish his standard and then maintain that standard throughout the competition. It is recommended that the contest director or organiser hold a conference prior to the start of competition to discuss judging so that the standards are as uniform as possible. This can be accomplished with demonstration flights that all judges score simultaneously and privately. After these flights, the defects in each manoeuvre should be discussed by all judges and agreement reached about the severity of the defects. After the competition is started, the individual judges should not alter their standard. Judging accuracy is also very important. Being consistent, whether high or low is not sufficient if the scores awarded do not fairly reflect the performed manoeuvre.

#### **5E.4 CRITERIA FOR JUDGING MANOEUVRES**

A description of each manoeuvre is provided in Annex 5D. Each manoeuvre should be downgraded according to:

- 1) The type of defect.
- 2) The severity of the defect.
- 3) The number of times a defect occurs.
- 4) The positioning of the manoeuvre.
- 5) The size of the manoeuvre relative to other manoeuvres.

A high score should be given only if no major defects are noted and the manoeuvre is accurately positioned. Whenever there is doubt a lower score should be given.

#### **5E.5 ATTITUDE AND FLIGHT PATH**

The flight path of the MA is the trajectory of its centre of gravity. The attitude is the direction of the fuselage (canopy, boom, etc) centreline in relation to the flight path. All judging should be based on flight path, but the angle between the flight path and the longitudinal axis should never exceed 10°.

#### **5E.6 GRADING CRITERIA FOR MANOEUVRE SEGMENTS**

The following criteria are furnished to provide the judge with a guide for downgrading deviations from the defined manoeuvre segments. The segments are: Takeoffs, Landings, Stops, Lines, Pirouettes, Loops, Rolls, Stall turns and Flips.

##### **5E.6.1. TAKEOFFS**

Takeoffs for the hovering manoeuvres must start from the centre of the 1m circle to obtain maximum score. Takeoffs must be smooth and the MA must ascend vertically until the skids or landing gear are at 2m over helipad. Non-vertical ascents where the MA moves forward or backward by half a fuselage length result in a downgrade of 1 point.

**5E.6.2. LANDINGS**

Landings for the hovering manoeuvres must be centred in the 1m circle of the helipad to obtain a maximum score. If a portion of the skids or landing gear is outside of the 1m circle (but rotor shaft points to the inside of the 1m circle when viewed from above), the downgrade is one point. A landing outside of the 1m circle (rotor shaft points to the outside of the 1m circle when viewed from above) results in a downgrade of 2 points. Non-vertical descents where the MA moves forward or backward by half a fuselage length result in a downgrade of 1 point.

**5E.6.3 STOPS**

For the hovering manoeuvres the stops must be equal to or greater than 2 seconds in duration if not otherwise specified. All stops must be of the same duration. If a stop is less than 2 seconds long, a downgrade of half a point should be made. If a stop is greater than 2 seconds, no downgrade should result as long as the MA does not move. In manoeuvres containing stops of unspecified duration (but are a necessary part of the manoeuvre) no downgrade shall be made for the stops.

**5E.6.4. LINES**

For the hovering manoeuvres the lengths of the lines are defined by the 10m distance between flags 1 and 2 and must be straight. Diagonal lines must be performed at the proper angle. However, the aerobic manoeuvres must be started and ended by equal horizontal lines of minimum length 10 m. A greater length of a vertical or climbing line, resulting from the performance of the MA, must not be allowed to positively influence a judge's score. One point should be subtracted for a recognisable difference. If there is a complete absence of a line, before or after a manoeuvre, 2 points should be subtracted.

**5E.6.5. PIROUETTES**

All pirouettes must be performed around the vertical axis. If the deviation is greater than 20° one point will be subtracted. During a hovering pirouette (stationary tail rotor turn), if the MA moves vertically or laterally by a noticeable amount, 1 point should be subtracted. If the vertical or lateral movement of the helicopter is significant (more than 25cm), 2 or more points should be subtracted. During an ascending pirouette, if the MA moves laterally by a noticeable amount, 1 point should be subtracted. If the MA's movement is greater than 25cm, 2 or more points should be subtracted. Travelling pirouettes must be synchronised with flight path. If the pirouettes are performed in the same direction for manoeuvres where pirouettes of opposite direction are prescribed, the score must be zero.

**5E.6.6. LOOPS**

A loop must, by definition, have a constant radius, and must be flown in a vertical plane. It starts and ends with a well-defined line, which for a complete loop will be horizontal. Every loop must be flown without segmentation. Every clearly seen segment should result in a downgrade of 1 point. If a loop is not flown entirely in a vertical plane, a minor drift should be downgraded by 1 point, while a more severe drift should be downgraded by several points.

**5E.6.7. ROLLS**

The roll rate must be constant. Small variations in roll rate should be downgraded by 1 point while more severe variations receive larger downgrades. Rolls (including partial rolls) must have crisp and well-defined starts and stops. If a start or stop is badly defined, 1 point is subtracted for each. Duration of the rolls must meet the minimum times specified.

**5E.6.8. TAIL TURNS**

The tail turns must be symmetrical by performing half of the rotation before and after the top. The tail turn must be around the main rotor shaft. If there is significant horizontal displacement, 1 point should be subtracted. The entry and exit must consist of partial loops with constant and equal radii.

**5E.6.9 STALL TURN**

The lines during this segment must describe vertical and horizontal flight paths. The model aircraft must come to a complete stop before a tail rotor turn is initiated. The tail rotor turn must be around the main rotor shaft. If there is significant horizontal displacement, one point should be subtracted. If the model aircraft shows a pendulum movement after the rotation, this should result in a downgrade of one point. The entry and exit must consist of partial loops with constant and equal radii.

*cont/...*



**5E.6.10. FLIPS**

Flips are stationary or travelling rotations about the lateral (elevator) axis of the MA. The direction of the flip is described according to the movement of the (elevator/longitudinal cyclic) control stick (Push = Negative - Nose down, Pull = Positive - Nose up). For the case of a stationary flip, one point should be subtracted if the MA moves forward or backward more than a fuselage length. For the case of a travelling flip, one point should be subtracted for a deviation of more than a fuselage length from the path of the described manoeuvre.

**5E.6.11. AUTOROTATIONS**

An autorotation begins when MA crosses an imaginary plane that extends vertically upward from a line drawn from the centre judge out through the centre of the 1m helipad. MA must be in the autorotation state when it cuts this plane, the engine power must be reduced to idle (or off) at this point and the MA must be descending. During the manoeuvre, the forward speed and rate of descent should be constant, which means that the angle of the flight path is also constant. After landing the MA must be parallel to the judges' line. If the flight path is stretched, shortened or deviated from, to reach a circle the manoeuvre must be downgraded. The original flight path gives a basic maximum score according to the description and there will be additional downgrades of 1 or 2 points depending of the severity of the deviation. For example: If the flight path clearly points to a landing close to flag 1 (2) and the path is stretched to reach a circle, the score can only be a maximum of 6 (outside the circles) and there will be an additional downgrade of 2 points for the stretch, so the score can only be a maximum of 4. If the pilot would have landed without stretching, the maximum score would have been a 6. Therefore, stretching the flight path must never lead to a higher score.

Scoring criteria for Autorotation landings:

Landing gear inside 1m circle = Maximum 10 points.

Rotor shaft points to inside of 1m circle = Maximum 9 points.

Landing gear inside 3m circle = Maximum 8 points.

Rotor shaft points to inside of 3m circle = Maximum 7 points.

Rotor shaft points to outside of 3m circle = Maximum 6 points.

**5E.7 WIND CORRECTION**

All manoeuvres are required to be wind corrected in such a way that the shape of the manoeuvre as described in Annex 5D is preserved in the MA's flight path.

**5E.8 POSITIONING**

All aerobatic manoeuvres must be performed within the 60° vertical and 120° horizontal viewing angle. Manoeuvres that are flown off centre will be downgraded according to the displacement. The downgrade may be in the range of 1 to 4 points. If a portion of a manoeuvre is flown outside of this air space a severe downgrade will occur. If the entire manoeuvre including entry and exit is flown outside of the window it must be scored zero points. Flying so far out as to make the evaluation of a manoeuvre difficult should also be severely downgraded. The main criterion here is visibility. Manoeuvres performed on a line further out than 100m away but in front of the judges should be downgraded in any case because even the keenest eye begins to lose perspective at that distance.

**PAGE DELIBERATELY LEFT BLANK**

## 5.11 CLASS F3N HELICOPTER FREESTYLE

### 5.11.1 Definition of a Radio Controlled Model Helicopter

A Radio Controlled (R/C) model helicopter is a heavier-than-air Model Aircraft (MA) that derives all of its lift and horizontal propulsion from a power driven rotor system(s) rotating about a nominally vertical axis (or axes). Fixed horizontal supporting surfaces up to 4 percent of the swept area of the lifting rotor(s) are permitted. A fixed or controllable horizontal stabiliser of up to 2% of the swept area of the lifting rotor(s) is permitted. Ground effect machines (hovercraft), convertiplanes or aircraft that hover by means of propeller slipstream(s) deflected downward are not considered to be helicopters.

### 5.11.2 General Characteristics

The swept area of the lifting rotor is not limited. The engine displacement is not limited. The use of pre-programmed flight manoeuvres is forbidden.

Limitations are:

- a) WEIGHT: The weight of the MA (with fuel or with batteries) must not exceed 6,5 kg.
- b) BATTERIES: Electric motors are limited to a maximum no load voltage of 51 volts for the propulsion circuit.
- c) ROTOR BLADES: All-metal main or tail rotor blades are prohibited.

### 5.11.3 Contest Area Layout

Refer to Figure 5.11.A. The drawing shows the recommended layout, the shape and distances of which should be kept for safety reasons.

### 5.11.4 Number of Helpers

After leaving the start box, the pilot is allowed on helper. The helper may give information to the pilot during the flight.

### 5.11.5 Number of Model Aircraft

The number of MA is not limited.

### 5.11.6 The Official Flight

There are three different flight programs: Set Manoeuvre flight, Freestyle flight and Music Freestyle flight. Before the flight the pilot has to be officially called. The MA can be flown or be carried to the flying area. The Set Manoeuvre flights begin when the MA leaves the start box. The Freestyle flights begin with the announcement of the start.

### 5.11.7 Scoring

The number of judges is at least three, and no more than five. At least 20% but not more than 40% of the judges must not have judged at the previous World Championships.

In the Set Manoeuvre flight each manoeuvre is given a score between 0 and 20 points by each judge. A manoeuvre that is not completed or not flown according to the description shall be scored zero (0) points. If a manoeuvre is scored zero points all judges must agree. In the freestyle or music freestyle flights the scoring is done after the flight according to the scoring criteria.

In the Set Manoeuvre flights, only manoeuvres that are completed in the flight time of 8 minutes will receive a score. If the flight time for the Freestyle or Music Freestyle program is less than three or more than four minutes, there shall be a downgrade of 5% for the flight. A flight shorter than two or longer than five minutes shall be scored zero points.

Manoeuvres must be performed where they can be seen clearly by the judges. If a judge, for some reason beyond the control of the competitor, is not able to follow the model aircraft through the entire manoeuvre, he may put a "Not Observed" (N.O.) mark. In this case, his score will, for that particular manoeuvre, be set to the average score given by the other judges, rounded to the nearest half point.

### 5.11.8 Classification

After the completion of every round, all scores will be normalised by awarding 1000 points to the highest scoring flight. The remaining scores are then normalised to a percentage in the ratio of actual score over the highest score of the round.

There shall be two rounds of Set Manoeuvre flights and one round each for Freestyle and Music Freestyle. However, the lowest score of each competitor will be the throwaway score. The other scores are added together and then divided by the number of counting preliminary rounds. The result is the preliminary score. If only one round is possible then the classification will be based on that round.

After completion of the preliminary flights, the top 10 competitors are entitled to three fly-off flights, one Set Manoeuvre flight, one Freestyle and one Music Freestyle flight. The normalised results of

the preliminary rounds for the top 10 pilots plus the three fly-off scores provide four normalised scores with the best three to count for the final individual classification.

At national and open international competitions the preliminary/fly-off system is not mandatory.

Ties will be broken by counting the throwaway score. If the tie still stands, a “sudden death” freestyle fly-off must take place until a decision is made.

#### 5.11.9 Organisation

The flight order for the first Set Manoeuvre round will be determined by a random draw. The flight order for rounds two (Freestyle), three (Set Manoeuvre) and four (Music Freestyle) will start after the first, second and third quarter of the initial order. The flight order for the fly-offs will be determined in the same manner.

**Preparation Time:** A competitor must be called at least 5 minutes before he is required to enter the start box. The MA may be hovered only up to 2m in the start box. After the preceding competitor has finished his flight, the competitor is given another minute (two minutes in Freestyle) to make last minute adjustments or checks, and then his flight time starts.

If the model leaves the start box earlier the flight time starts at that moment.

#### 5.11.10 Flight Program

##### Safety During the Flights

The prohibited flying area (see figure 5.11.A) is observed by the judges. If the safety line is crossed the flight shall be scored zero points.

The competitor may choose his position during the flight with the following constraints:

- (a) The MA must not be flown between the pilot and judges.
- (b) The pilot must stand in front of the judges.

The non-observance of these constraints will be penalised by a zero score in the safety criterion for the manoeuvre or the flight in Freestyle.

If, during a flight in any of the schedules, a part of the helicopter except the landing gear or tail fin touches the ground the flight is terminated and scored zero points. This does not apply to the MA tilting over after a landing or autorotation.

##### Set Manoeuvre Flight

Every pilot makes his choice of eight different manoeuvres from the list of manoeuvres (refer to paragraph 5.11.11). He may choose different manoeuvres for each round. The list with the manoeuvres chosen for a round must be delivered to the Contest Director or an official before the beginning of the round. The flight time of the Set Manoeuvre rounds is eight minutes.

##### Freestyle Flight

Each competitor is given a flight timeframe of at least three, and no more than four minutes. During this time there are no restrictions for the flight or the performed manoeuvres except those regarding safety. The play-back of music is not allowed. The flight time begins when the helper gives a distinctive hand signal and finishes only with another distinctive helper hand signal.

##### Music Freestyle Flight

The same criteria as in Freestyle, but the play-back of music during the flight is prescribed. The flight time begins when the helper gives a distinctive hand signal and finishes only with another distinctive helper hand signal. If the music starts before the flight, the flight time starts not later than 15 seconds after the start of the music.

#### 5.11.11 Optional Manoeuvres

The Optional Manoeuvre list that is changed on a yearly basis after approval by CIAM Bureau will be available from the F3 Helicopter Subcommittee Chairman at the beginning of each year.

*Note: It may not be possible to include in the F3 Helicopter volume of the Sporting Code the Optional Manoeuvres that are approved annually by Bureau at its December meeting.*

*The F3N Contest Area Layout appears overleaf.*

**FIGURE 5.11.A – F3N CONTEST LAYOUT AREA**

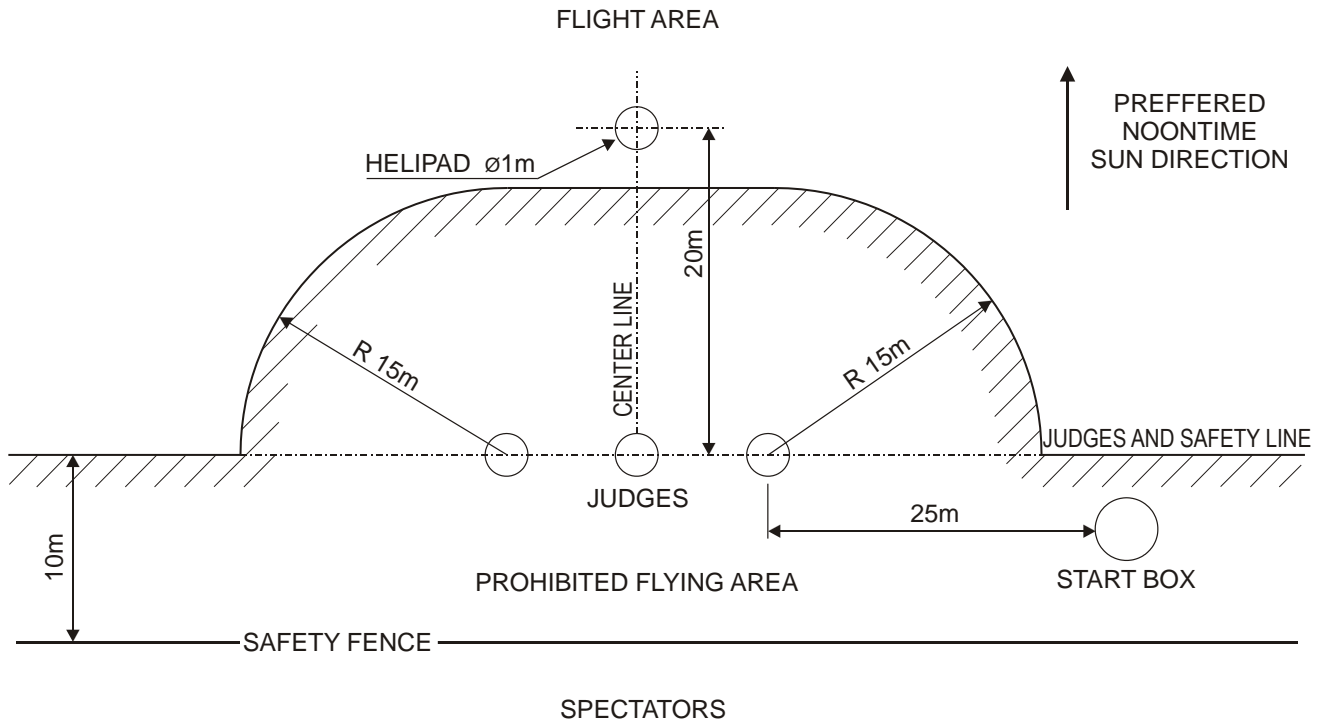

*The manoeuvre descriptions appear on the next page.*

**PAGE DELIBERATELY LEFT BLANK**

## ANNEX 5F

### F3N MANOEUVRE DESCRIPTIONS AND DIAGRAMS

#### 5F.1 F3N SET MANOEUVRE DESCRIPTIONS

- (a) The list of Set Manoeuvres contains 30 manoeuvres (listed below) and ten optional manoeuvres. The optional manoeuvres must be selected by the organiser at least 6 months prior to the competition from a list that is available from the F3 Helicopter Subcommittee Chairman. This list will be revised by the F3 Helicopter Subcommittee on a yearly basis and will be approved by the CIAM Bureau.
- (b) The competitor or his caller must announce the name and start and finish of each manoeuvre. All aerobatic manoeuvres start and end with a straight and level flight of 10 metres minimum length parallel to the judges' line. All manoeuvres from stationary flight start and end with a hovering of at least 1 second with the MA parallel or vertical to the flight line. All manoeuvres (considering also entry and exit) should be performed symmetrical to the centre line. The drawings in paragraph 5.11.12 illustrate the manoeuvres, in case of a dispute the following text takes precedence over the drawings. All manoeuvres can also be flown in opposite direction to that shown in the drawings.

Number	Description	K-Factor
1.1	<b>Inside loop</b> MA performs an inside loop.	3.5
1.2	<b>Inverted pirouette</b> MA hovers in inverted flight and performs a slow (at least 4 seconds) 360°-pirouette, maintaining its lateral position.	4.0
1.3	<b>Backward circle</b> MA enters the manoeuvre backwards in upright flight and performs a horizontal circle aligned o the centre line.	4.0
1.4.	<b>Double Immelmann</b> MA performs a half inside loop immediately followed by a half roll to upright flight. After a straight flight of about 20 metres MA performs a half outside loop, again immediately followed by a half roll to upright flight.	4.0
1.5	<b>Double roll backwards</b> MA enters in upright backward flight and performs two consecutive axial rolls.	4.5
1.6	<b>4-point roll</b> MA enters in upright forward flight and then performs 4 quarter rolls, separated each by a recognisable straight segment of the same duration.	4.5
1.7	<b>Outside loop with half rolls</b> MA performs a half roll to inverted flight, followed by a recognisable straight segment and then enters an outside loop (upward). After the loop, MA flies another recognisable straight segment, followed by a half roll to upright flight.	5.0
1.8	<b>Inverted horizontal eight</b> MA enters in inverted forward flight parallel to the judges' line, performs a 90°-turn to a straight flight above the centre line and then performs a horizontal eight, consisting of two 360° circles.	5.0
1.9	<b>Backward knife edge pirouette</b> MA enters in upright backward flight, transitions to a slight ascent (max 15°) and performs a quarter roll. After a recognisable straight segment MA performs a 360°-pirouette, followed by another straight segment and a quarter roll in opposite direction to the first to upright backward flight.	5.5
1.10	<b>Four pushed half flips</b> MA hovers in upright position, then performs four half pushed flips (forward) each separated by a hovering of 2 seconds. MA maintains its position during the manoeuvre.	5.5
1.11	<b>Tic-toc (Metronome)</b> MA hovers and then is rotated (Nose up) about 135°. It then starts rotating alternately about the lateral axis by about 90° forward or backward. Both 45° positions have to be reached at least three times. The tail rotor stays almost in the same position during the manoeuvre.	6.0

<b>Number</b>	<b>Description</b>	<b>K-Factor</b>
<b>1.12</b>	<b>360°-turn with roll</b> MA enters in upright forward flight and performs a quarter (inside) loop to a vertical climb. Just before the stall, MA performs a 360°-pirouette to a vertical (backward) dive, followed by another quarter (inside) loop to upright flight and an axial backward roll.	<b>6.0</b>
<b>1.13</b>	<b>Backward loop</b> MA enters in upright backward flight and performs an inside loop with the tail always pointing in flight direction.	<b>6.5</b>
<b>1.14</b>	<b>4-point roll backwards</b> MA enters in upright backward flight and then performs 4 quarter rolls, separated each by a recognisable straight segment of the same duration. The tail of the MA always points in the flight direction.	<b>6.5</b>
<b>1.15</b>	<b>Inverted backwards horizontal eight</b> MA enters in inverted backward flight parallel to the judges' line, performs a 90°-turn to a straight flight above the centre line and then performs a horizontal eight, consisting of two 360° circles with the tail always pointing in flight direction.	<b>7.0</b>
<b>1.16</b>	<b>Rolling circle</b> MA performs a horizontal circle while it performs consecutive axial rolls. MA speed, rolling rate and the radius of the circle should be constant.	<b>7.5</b>
<b>1.17</b>	<b>4 rainbows with half rolls</b> MA performs a rainbow (a semicircle with the lateral axis always vertical to the flight path) to a recognisable stop, then a stationary half roll to another stop. Then it enters another rainbow to a stop on the position of the start of the manoeuvre, followed by another half roll and continues like that, until four rainbows and four half rolls are completed.	<b>7.5</b>
<b>1.18</b>	<b>Funnel</b> MA enters in inverted flight and performs a quarter pirouette. MA then performs three superimposed circles in lateral inverted flight with the rotor disk tilt at least 45 degree from a horizontal plane. The diameter of the circles should be at least 10 metres.	<b>7.5</b>
<b>1.19</b>	<b>Snake</b> MA enters in upright backward flight and then describes a sinuous line by alternately performing upright and inverted circle segments of equal diameter and length. There should be at least four complete circle segments and the length of the manoeuvre should be at least 50 metres.	<b>8.0</b>
<b>1.20</b>	<b>Triple pirouetting flip</b> MA hovers and then starts pirouetting. At the same time or after one pirouette the MA starts to flip three times while it continues to perform pirouettes. There should be at least one pirouette during each 360° flip (2 pirouettes are shown in the drawing). Both rotations should have a constant rate and the MA maintains its position during the manoeuvre.	<b>8.0</b>
<b>1.21</b>	<b>Cuban eight backwards</b> MA enters in upright backward flight and performs a 5/8 inside loop to a 45°-descent. It performs a half roll, followed by a 3/4 inside loop and another half roll in 45°-descent. MA then finishes the first partial loop to upright backward flight. The tail of the MA always points in the flight direction.	<b>8.0</b>
<b>1.22</b>	<b>Pirouetting loop</b> MA enters in upright flight and starts performing pirouettes. Then it performs an inside loop while constantly rotating about the yaw axis. During the loop there have to be at least 2, max 6 pirouettes. The pirouettes should be distributed equal on the loop.	<b>8.0</b>
<b>1.23</b>	<b>Backward rolling circle</b> MA enters in backward flight and performs a horizontal circle while it performs consecutive axial rolls. MA speed, rolling rate and the radius of the circle should be constant and the tail of the MA always points in the flight direction.	<b>9.0</b>
<b>1.24</b>	<b>Waltz</b> MA enters in inverted flight and performs a quarter pirouette (tail turns to circle centre) to enter a funnel. After a quarter funnel MA performs a complete smaller funnel (max. half diameter of the first) then continues with another quarter larger funnel, followed again by a complete smaller funnel etc. After the larger funnel is completed there is again a complete smaller funnel, followed immediately by another quarter pirouette to the exit in inverted flight. The diameter of the large funnel should be at least 20 metres.	<b>8.5</b>

cont/...



<b>Number</b>	<b>Description</b>	<b>K-Factor</b>
<b>1.25</b>	<b>Double 4-point Tic-toc</b> MA hovers and then is rotated (Nose up) about 135°. It then starts rotating alternately about the lateral axis for about 45° in each direction. Both 45°-positions have to be reached one time (ie one tic-toc) and then the MA performs a quarter pirouette. It performs another complete tic-toc in this position, then again performs another quarter pirouette and so on, until it performed two complete pirouettes while executing tic-tocs.	<b>9.0</b>
<b>1.26</b>	<b>Pirouetting funnel</b> MA enters in inverted flight and then starts pirouetting whereas it performs three superimposed circles in lateral inverted flight with the rotor disk tilt at least 45 degree from a horizontal plane. The diameter of the circles should be at least 10 metres and there should be at least three pirouettes during each circle.	<b>8.5</b>
<b>1.27</b>	<b>Funnel with half rolls</b> MA enters in inverted flight and performs a quarter pirouette. MA then performs three superimposed circles in lateral inverted flight with the rotor disk tilt at least 45 degree from a horizontal plane. After each half funnel except the last the MA performs a half roll. After three funnels (and five half rolls) the MA exits in upright flight. The diameter of the circles should be at least 10 metres.	<b>9.5</b>
<b>1.28</b>	<b>Square of rainbows</b> MA hovers and enters the manoeuvre with a rainbow, ie a not stationary flip that follows a semi-circular flight path of at least 10 metres diameter. On top of the rainbow the MA performs a half flip about the axis that is vertical at this point (e.g. on a pulled rainbow the MA performs a flip about the longitudinal axis (like a half roll); on a rainbow flown sideways it performs a half (pushed or pulled) flip). MA then hovers and enters another rainbow, alternately about the longitudinal and the lateral axis, until it reaches the starting position after the fourth rainbow. The four hovering positions between the rainbows are situated on the edges of a square of at least 10 metres.	<b>9.0</b>
<b>1.29</b>	<b>Four-way pirouetting tic-toc</b> MA hovers and starts pirouetting. It then is rotated about 135° and continues rotating alternately about the lateral or the longitudinal axis for about 45° in each direction while it performs pirouettes of a constant rate. Both 45°-positions have to be reached two times (i.e. two tic-tocs). After two tic-tocs MA changes the direction of the tic-tocs about 90° (viewed from above), performs two more tic-tocs, changes the direction again about 90° and continues until 2 pirouetting tic-tocs in all 4 directions are performed.  There has to be at least one complete pirouette on each tic-toc	<b>10.0</b>
<b>1.30</b>	<b>Pirouetting globe reversal</b> MA enters in upright flight and then performs four pirouetting loops. During each loop, the flight path is changed continually in a way, that the low point is passed rotated about 45° (seen from above) until a complete globe has been described.  After each loop the pirouetting direction is changed. The MA exits the manoeuvre at the same altitude but in opposite direction to the beginning. During each loop, the MA must perform at least two pirouettes	<b>10.0</b>

*The manoeuvre drawings appear on the next page.*

**5F.2 SET MANOEUVRE DRAWINGS**

**Set Manoeuvres 1 – 18 (of 30)**

1. Inside loop K 3.5

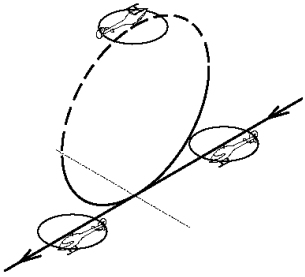

2. Inverted pirouette K 4

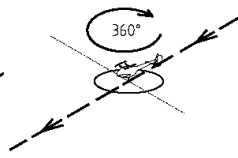

3. Backward circle K 4

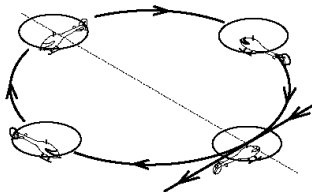

4. Double Immelmann K 4

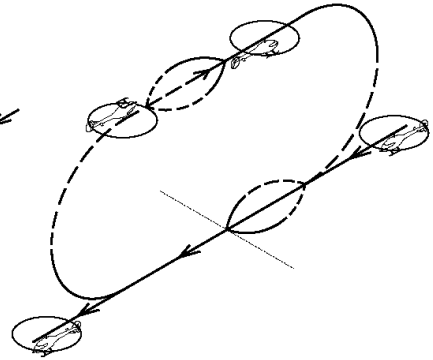

6. 4-point-roll K 4.5

5. Double roll backwards K 4.5

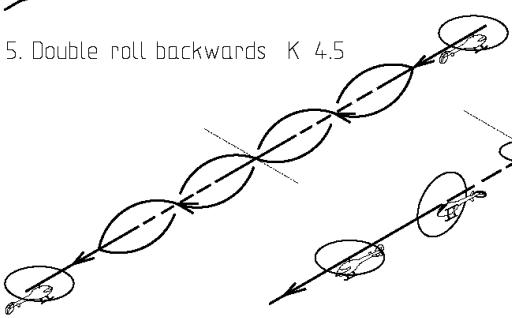

7. Outside loop with half rolls K 5

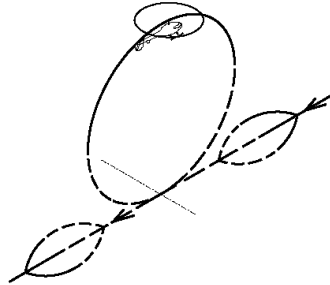

8. Inverted horizontal eight K 5

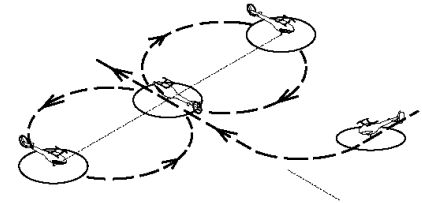

9. Backward knife edge pirouette K 5.5

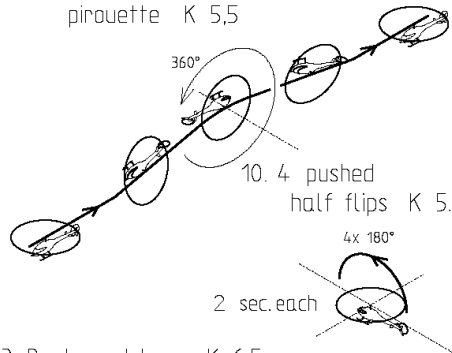

10. 4 pushed half flips K 5.5

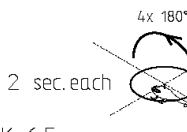

11. TicToc K 6

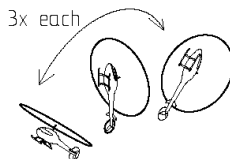

12. 360°-turn with roll K 6

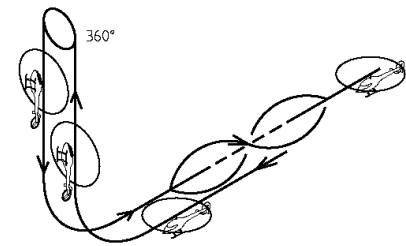

13. Backward loop K 6.5

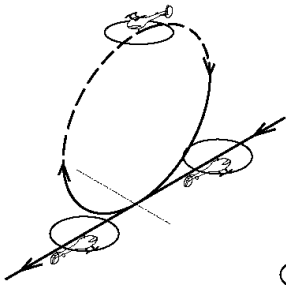

14. 4-point roll backwards K 6.5

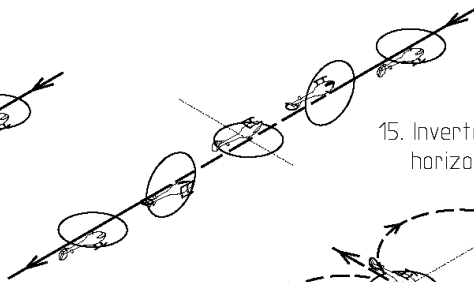

15. Inverted backwards horizontal eight K 7

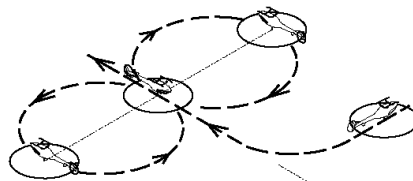

16. Rolling circle K 7.5

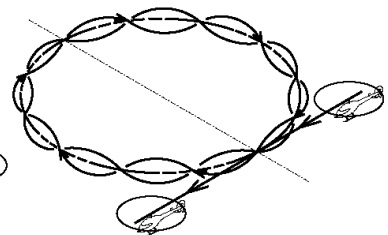

17. 4 rainbows with half rolls K 7.5

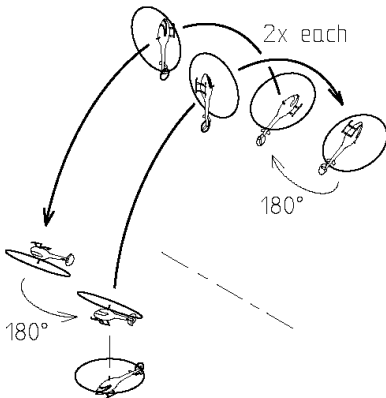

18. Funnel K 7.5

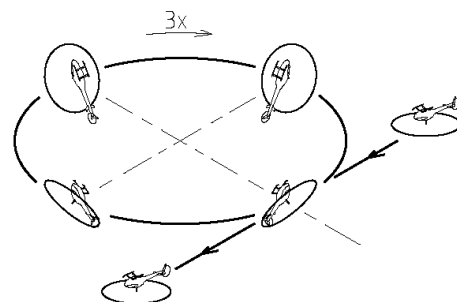

Set Manoeuvres 19 – 30.

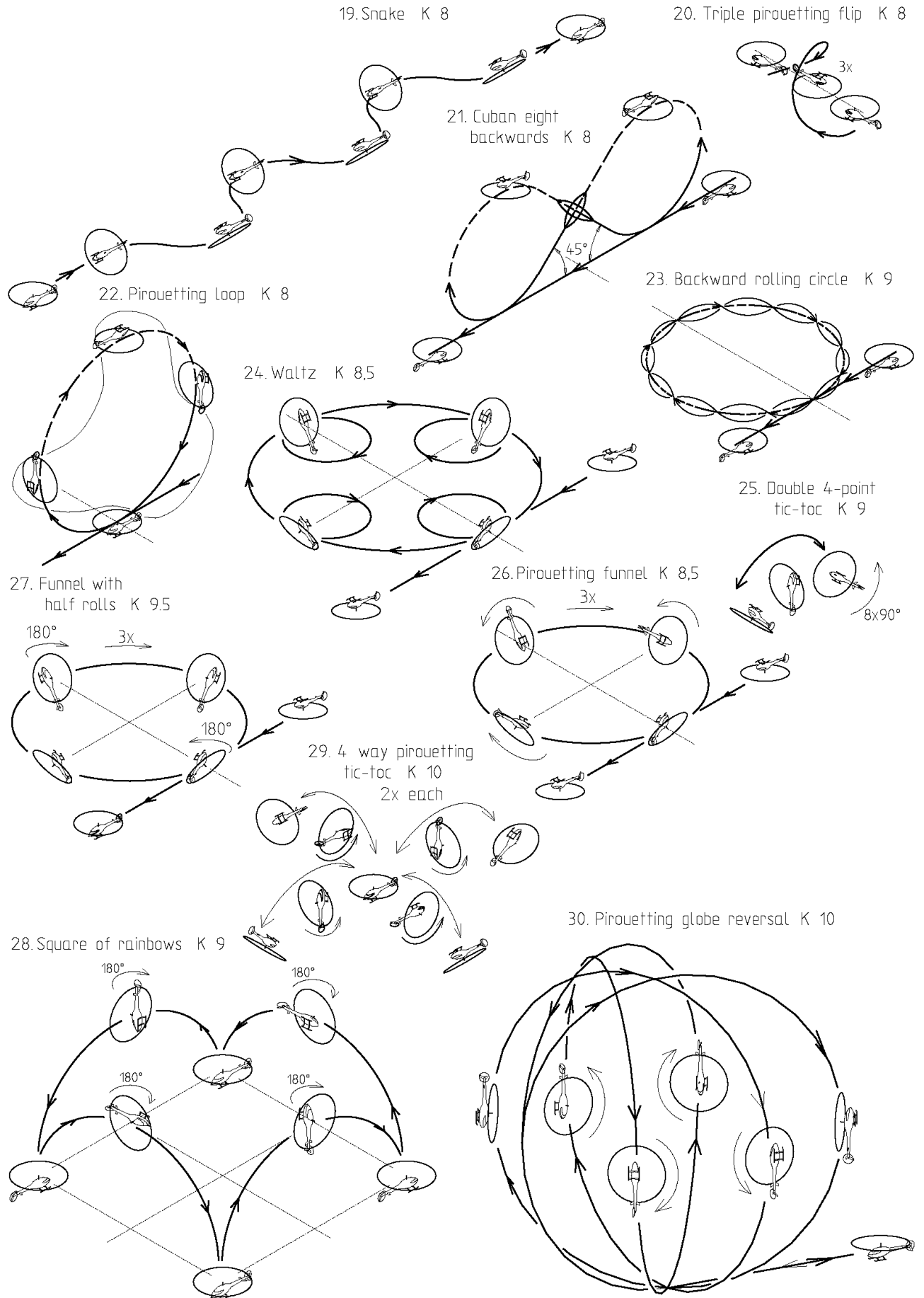

**PAGE DELIBERATELY LEFT BLANK**

### 5F.3 CLASS F3N OPTIONAL MANOEUVRE LIST

The Optional Manoeuvre list will be available from the F3 Helicopter Subcommittee Chairman at the beginning of each year.

The optional manoeuvres will be labelled B1 through B10.

Each year the optional manoeuvres will be modified or changed to adapt to the rapidly evolving F3N class. Organisers of F3N competitions must announce the use of a new list if appropriate at least 6 months prior to the event. The following will apply:

- For World or Continental Championships all optional manoeuvres must come from the annual list.
- For National Championships it is recommended that at least 5 manoeuvres should come from this list.
- For local competitions the organiser does not have to use manoeuvres from this list.

<b>Number</b>	<b>Description</b>	<b>K-Factor</b>
<b>B.1</b>	<b>Two Opposite Piro Funnels</b>	<b>10.0</b>
	<p>MA enters in inverted forward flight, performs a quarter pirouette and starts an inverted funnel with the tail pointing to the centre. When it crosses the centreline it enters a circle and starts pirouetting in a way, that after each quarter circle the fuselage has changed its direction 180° (e.g. model starts from right to left, after a quarter circle the tail points to the flightline, after a half circle away from centre, after 3 quarters to the flightline again and after the circle to centre again). After one circle the pirouetting direction is changed, and a second circle follows with the same conditions for the pirouette. After the second circle MA exits the manoeuvre in inverted forward flight.</p>	
<b>B.2</b>	<b>Double O One</b>	<b>10.0</b>
	<p>MA enters in forward upright flight parallel to the flight line. Model performs ¼ of a loop. After the ¼ loop the boom is vertical, and model is on centre line. MA then performs one complete outside loop. During the first half of the loop, the model performs half pirouette, and during the second half of the loop, the model performs another half pirouette in opposite direction. MA is now back to same point on the centreline and with same orientation as when the complete loop started. Model now performs a complete inside loop, with pirouettes similar to the first complete loop. After second complete loop, MA continues vertical upwards, makes a slow half roll symmetrical to the stall point, and exits in backward inverted flight to the same side and height as the entry came from.</p>	
<b>B.3</b>	<b>Piro Globe double reversed</b>	<b>10.5</b>
	<p>MA enters in upright flight and then performs four pirouetting loops. During each loop, the flight path is changed continually in a way that the low point is passed rotated about 45° (seen from above) until a complete globe has been described.</p> <p>After each loop the pirouetting direction is changed at the bottom of the loop. MA performs on every top of the loop a half roll in either direction while still performing pirouettes. The MA exits the manoeuvre at the same altitude but in opposite direction to the beginning. During each loop, the MA must perform at least two pirouettes.</p>	
<b>B.4</b>	<b>Rolling circle reversal</b>	<b>9.5</b>
	<p>MA enters in forward flight and performs a horizontal circle while it performs axial rolls. The direction of rotation of the rolls must be changed after each quarter circle without hesitation between the rolls. MA speed, rolling rate and the radius of the circle should be constant.</p>	
<b>B.5</b>	<b>Galaxy</b>	<b>10.5</b>
	<p>MA enters in upright flight, performs a quarter pirouette and starts a funnel with the tail pointing to the centre. During the funnel the radius of the circular flight path decreases and the declination of the rotor disc increases, so the path becomes a spiral. After 720° (2 spiral shaped "circles") the declination should be about 60°. Then a smaller half funnel follows where the declination of the rotor disc becomes vertical when the model crosses the imaginary centre point of the funnel spiral. When MA crosses this point it performs a half pirouette and immediately continues with a small half nose down inverted funnel (the flight path has the shape of an S here when viewed from above), followed by two inverted funnels (the nose now pointing to the circle centre) with increasing radius (and</p>	

decreasing declination of the rotor disc) and exits the manoeuvre in inverted flight in the same direction but in a different distance as the entry.

During the manoeuvre the height of the flight path must be changed to be symmetrical to the point where the model crosses the centre point, i.e. it may climb during the first 2 1/2 funnels and decline during the second 2 1/2 by the same amount.

**B.6 Cuban 8 with roll reversal 10**

MA enters in upright backward flight. When crossing the centre line it starts continuous rolls. While rolling, MA performs half Cuban 8 parallel to the flight line. Symmetrically around the centreline, MA stops rolls, performs half pushed elevator flip, and restarts rolling in opposite direction. MA is now in forward flight while rolling. MA then performs second half of the Cuban 8 while continuously rolling. Symmetrically around the centreline, MA stops rolls, performs half pushed elevator flip, and restarts rolling in the same direction as was used at the manoeuvre start. MA stops rolling and exits in upright backward flight.

**B.7 Vertical tic-toc eight 10.5**

MA enters in upright forward flight and performs a quarter roll to knife edge tic-tocs. Model then performs a half tic-toc loop. On the top of the loop MA performs a half pirouette, and then continues up with another half tic-toc loop while keeping the tail in the flight direction. On top of this second circle MA performs a half roll. It completes the upper tic-toc loop with the tail in the flight direction. It then performs another half pirouette and completes the lower tic-toc loop with the nose in the flight direction. Model exists in upright forward flight

During the manoeuvre the longitudinal axis of the model always follows the flight path

**B.8 Funnel with half rolls and pirouettes 10.0**

Model enters in inverted flight and performs a quarter pirouette before crossing centreline. Model then performs two superimposed horizontal circles with the rotor disk tilt at least 30 degree from a horizontal plane. After each half funnel (except the last) the model performs a half roll. On each half circle, model performs an integrated half pirouette. Direction of pirouette must change after each half roll. After two funnels (and three half rolls) the model exits in upright flight via a quarter pirouette. The diameter of the circles should be at least 10 metres.

**B.9 Four point tic-toc reversal 9.0**

MA hovers with the tail to the judges' line and is brought to vertical position (Nose up) about 135°. It then starts rotating alternately about the lateral axis for about 45° in each direction. Both 45°-positions have to be reached one time (i.e. one tictoc) and then the MA performs a quarter pirouette in clockwise direction. It performs another complete tictoc in this position, then again performs another quarter pirouette in clockwise direction and so on. After the MA has performed a complete pirouette, the MA starts immediately a second 4-time tictoc in anti-clockwise direction. The MA maintains its position during the manoeuvre.

**B.10 Duus Igloo 10.0**

MA is hovering upright nose in on centre line. Model then performs half pulled rainbow away from the pilot, while also doing an integrated half pirouette. At top of rainbow model makes sharp quarter aileron roll, and completes second half of the rainbow parallel with flight line while making another integrated half pirouette until model hovers inverted shortly, now with boom parallel to flight line. Same sequence is then repeated 3 times, until MA is back at starting point. Viewed from above, the manoeuvre will look like a +. Notice hovering is inverted after first and third sequence.

*The Optional Manoeuvre diagrams appear overleaf.*

### 5F.4 Optional Manoeuvre Drawings

Optional Manoeuvres 1-5 (of 10)

B.1 Two opposite pirofunnels

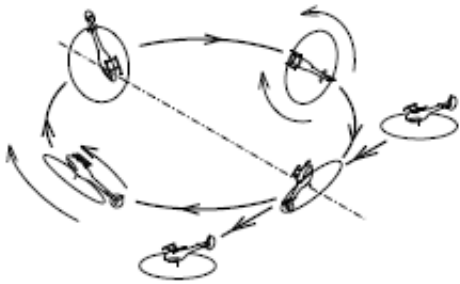

B.2 Double O one

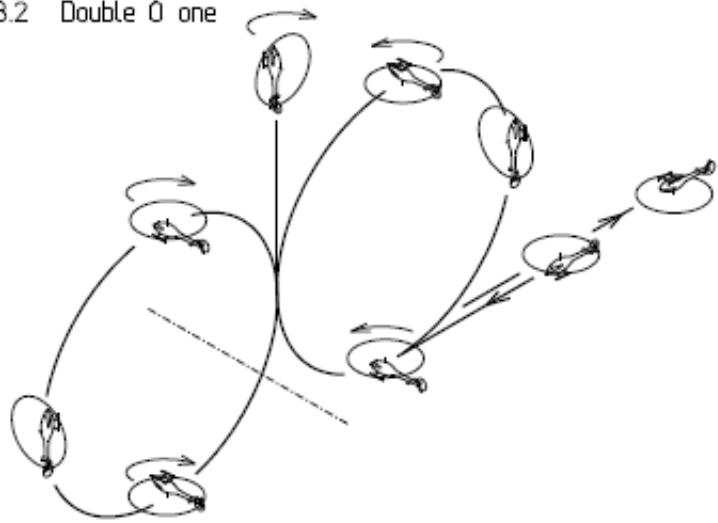

B.3 Piro globe double reversed

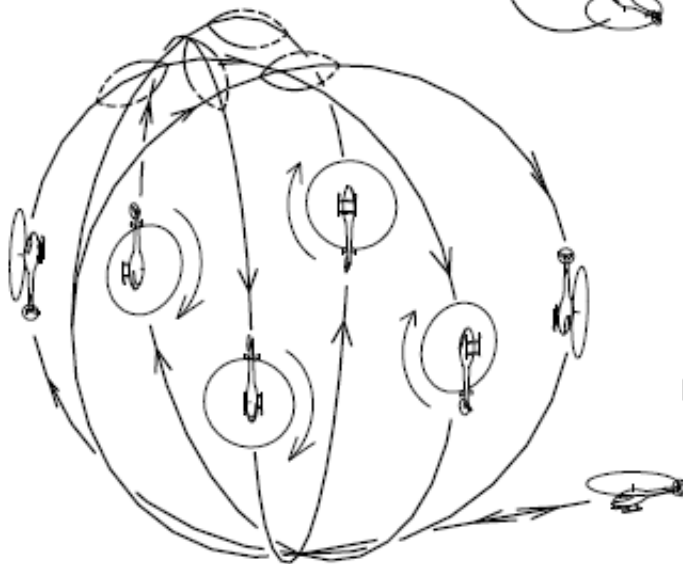

B.4 Rolling circle reversal

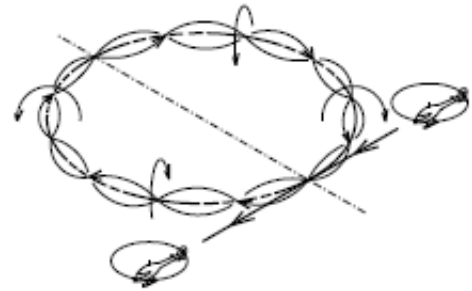

B.5 Galaxy

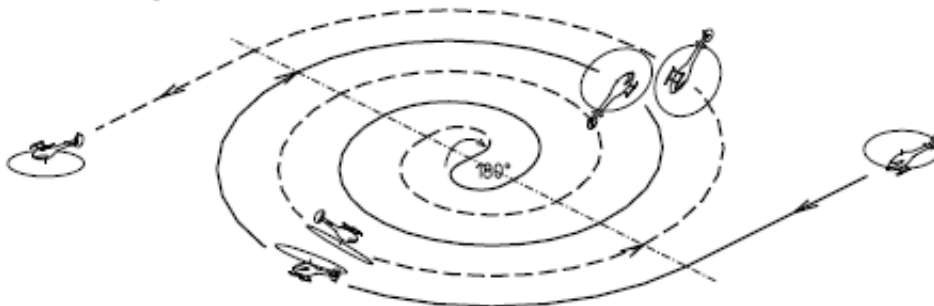

### Optional Manoeuvres 6 -10

#### B.6 Cuban eight with roll reversal

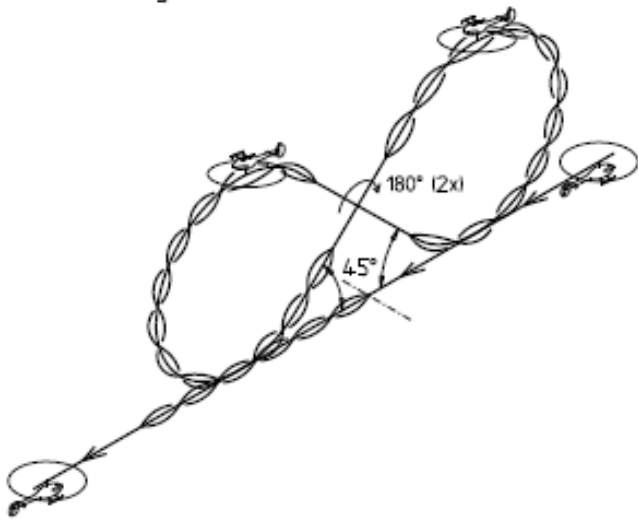

#### B.7 Vertical tic-tac eight

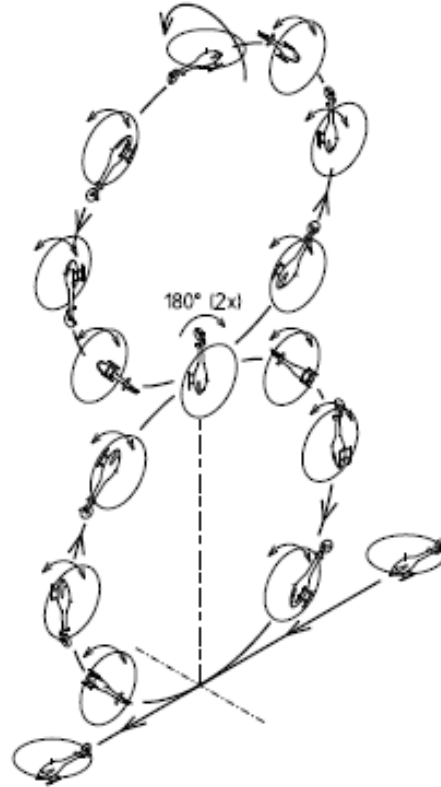

#### B.8 Funnel with half rolls and pirouettes

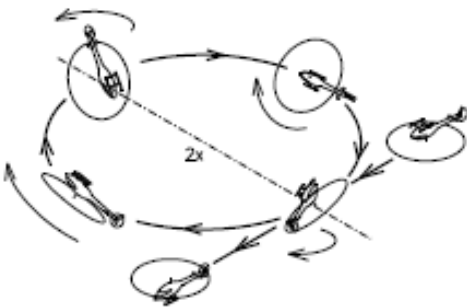

#### B.9 4-point tic-tac reversal

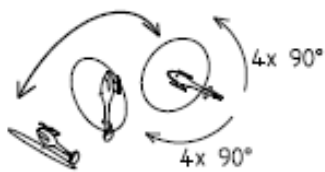

#### B.10 Duus Igloo

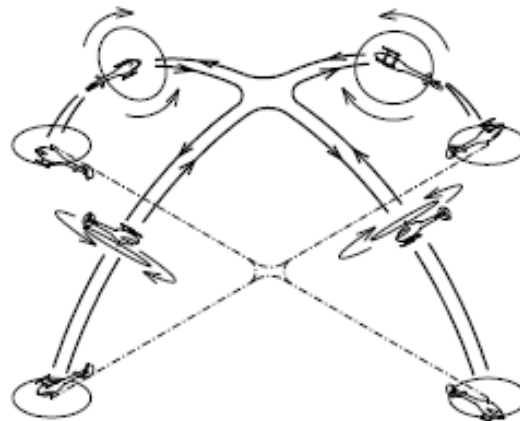



## **ANNEX 5G**

### **F3N JUDGES GUIDE**

#### **5G.1 PURPOSE**

The purpose of the F3N judges guide is to provide an accurate description of the major judging criteria to serve as a reference for use in developing a uniformly high standard of judging.

#### **5G.2 PRINCIPLES**

The principles of judging a radio controlled model helicopter should be based on the perfection with which the model aircraft performs each set manoeuvre as described in Annex 5F.11.

The main principles used to judge the degree of perfection are:

- 1) Precision of the manoeuvre.
- 2) Smoothness and gracefulness of the manoeuvre.
- 3) Positioning or display of the manoeuvre.
- 4) Size of the manoeuvres relative to each other.

The requirements are listed in order of importance; however, all of them must be met for a manoeuvre to receive a high score or even the maximum of 20 points.

Basically all judging starts with the respective point maximum, from where points are subtracted according to the grading criteria of this guide.

#### **5G.3 ACCURATE AND CONSISTENT JUDGING**

The most important aspect of judging is consistency. Each judge must establish his standard and then maintain that standard throughout the competition. It is recommended that the contest director or organiser hold a conference prior to the start of competition to discuss judging so that the standards are as uniform as possible. This should be accomplished with demonstration flights that all judges score simultaneously and privately. After these flights, the defects in each manoeuvre should be discussed by all judges and agreement reached about the severity of the defects. After the competition is started, the individual judges should not alter their standard. Judging accuracy is also very important. Being consistent, whether high or low is not sufficient if the scores awarded do not fairly reflect the performed manoeuvre.

#### **5G.4 CRITERIA FOR JUDGING MANOEUVRES**

A description of each set manoeuvre is provided in Annex 5F.11.

Each manoeuvre should be downgraded according to:

- 1) The type of defect.
- 2) The severity of the defect.
- 3) The number of times a defect occurs.
- 4) The positioning of the manoeuvre.
- 5) The size of the manoeuvre relative to other manoeuvres.

A high score should be given only if no major defects are noted and the manoeuvre is accurately positioned. Whenever there is doubt a lower score should be given.

#### **5G.5 ATTITUDE AND FLIGHT PATH**

The flight path of the model aircraft (MA) is the trajectory of its centre of gravity. The attitude is the orientation of the rotor disc (RD) in relation to the flight path. All judging should be based on the flight path, but the angle between flight path and RD should not exceed 15° (if not specified otherwise). For higher angles one point per 5° should be subtracted.

#### **5G.6 GRADING CRITERIA FOR MANOEUVRES AND SEGMENTS**

The set manoeuvres are composed of segments. The following criteria are furnished to provide the judge with a guide for downgrading deviations from the defined manoeuvre segments.

These segments are: Loop, Roll, horizontal Circle, Turn, Pirouette, Autorotation, Flip, Tic-Toc, Rainbow, Snake and Funnel or parts of them. If a manoeuvre contains several segments of the same type than these have to be similar, e.g. same radii for loops, same roll rates for rolls, same pirouette turning rates etc.

Basically all aerobatic manoeuvres start and end with a straight and level flight of 10 metres minimum length parallel to the judges line (except horizontal eights). All manoeuvres from stationary flight start and end with a hovering of at least 1 second with the model parallel or vertical to the flight line. If one of these segments is missing 2 points should be subtracted.

*cont/...*

If the orientation of the entire manoeuvre or segments of it is not parallel to the defined line or plane, 1 point per each 5° deviation should be subtracted. If the manoeuvre is not positioned symmetrically to the centreline a downgrade of 1 point per each 5 m should be made.

These two guides (1 point per 5° and 1 point per 5 m) can also be used as a rule of thumb when in doubt and if the downgrades are not defined otherwise.

If the flight altitude changes in horizontal passages a downgrade of 1 point per 2 m for aerobatic and of 1 point per 50 cm for hovering manoeuvres should be made.

In general every severe mistake should also lead to a severe downgrade about 6 points, a medium defect to about 3 points and a small deviation to about one point. Of course the number of mistakes has a big influence too, if a manoeuvre has many severe defects the first one will result in 6 points downgrade, the second one in 4 points, the third in 2 and every further in 1 point. If, in spite of many severe mistakes, the manoeuvre is still recognisable and no parts are missing, the score should not fall below 5 points. If entire segments are missing or the manoeuvre is completely unrecognisable the score must be zero.

#### **5G.6.1 LOOP**

A loop must have a constant radius and must be flown in a vertical plane. MA attitude and flight path have to differ to keep the momentum (but less than 15°). The speed of MA should not vary too much and the radius must be smooth and not segmented.

#### **5G.6.2 ROLL**

A roll is a rotation about the longitudinal axis of MA. To keep the momentum, for a horizontal roll the longitudinal axis must maintain its angle to a horizontal plane. Start and end of rolls should be crisp and well defined.

#### **5G.6.3 HORIZONTAL CIRCLE**

MA speed and circle diameter should be chosen in a way that a circle is flown with less than 20° declination of RD. MA speed and circle diameter have to be constant.

#### **5G.6.4 TURN**

A turn is a rotation about the yaw axis after a vertical ascent and just before the complete stop of MA. This rotation must be symmetrical by performing half of it before and the other half after the moment MA comes to a halt. The rotation must be of constant rate without interruptions, with crisp and well defined start and end.

#### **5G.6.5 PIROUETTE**

A pirouette is a rotation about the yaw axis. The rotation must be of constant rate without interruptions, with crisp and well defined start and end. Since in F3N pirouettes are not flown stationary but only combined with other manoeuvre segments (like loops, flips and funnels) it is important, that the pirouette does not affect the flight path.

#### **5G.6.6 AUTOROTATION**

During this manoeuvre the model should follow an almost straight flight path from the start to the landing on the helipad. This path may be interrupted by a flip or roll but should be resumed after this. If the landing point is not in the circle, a downgrade of 1 point per 1 m distance should be made.

#### **5G.6.7 FLIP**

A flip is a rotation about an axis normal to the rotor shaft. Stationary flips need to have a small altitude oscillation (low with RD horizontal, high with RD vertical) which should be less than 50 cm. Lateral deviations of these flips should be downgraded by 1 point per 50 cm.

Travelling flips should not affect the described flight path.

#### **5G.6.8 TIC-TOC**

MA hovers or moves slowly and is rotated using cyclic pitch about 135°. It then rotates its RD in a 90° arc back and forth. A movement of the centre of gravity of less than 2 m for simple tic-tocs or less than 5 m for tic-tocs with pirouettes should not lead to a downgrade, for greater deviations 1 point should be subtracted for the mentioned distances.

#### **5G.6.9 RAINBOW**

A rainbow is a semicircle, starting from hovering, with RD always normal to the flight path. The diameter of the semicircle should not be less than 10 m. The start and stop shall be crisp and well defined.

*cont/...*

**5G.6.10 SNAKE**

While in fast flight MA follows a wavy line by alternately performing upright and inverted quarter circular segments of equal diameter and length.

During these circular segments the banking must not fall below 45°. A banking of less than 20° means just an array of quarter circles but not a snake and makes the manoeuvre unrecognisable, ie zero points.

**5G.6.11 FUNNEL**

A funnel is a circle with at least 10 m diameter, performed with a declination of RD of at least 45° from a horizontal plane. MA speed, declination and circle diameter should be constant. A declination of less than 20° means just a horizontal circle but not a funnel and makes the manoeuvre unrecognisable, ie zero points.

**5G.6.12 REVERSAL**

Cyclic or pirouette reversals must be performed in a way, that the number of rotations in each direction is almost equal. A relation of e.g. 2:1 should lead to a downgrade of 4 points.

If not defined otherwise, the direction of rotation should alter after every 360° rotation.

**5G.7 WIND CORRECTION**

All manoeuvres are required to be wind corrected in such a way that the shape of the manoeuvre as described in Annex 5F.11 is preserved in the model aircraft's flight path.

To countervail lateral wind (in horizontal or vertical passages) MA must turn its longitudinal axis against the wind. This attitude must not lead to a downgrade as long as the flight path is correct.

Wind parallel to the flight line must be compensated with pitch in vertical passages, an angle between flight path and attitude will in that case lead to a downgrade of 1 point per 5°.

**5G.8 CRITERIA FOR JUDGING FREESTYLE FLIGHTS**

For freestyle or music freestyle flights the entire flights will be judged according to the following spreadsheet:

Criterion	Max Points Freestyle	Max Points Music Freestyle
Difficulty	80	40
Harmony	20	40
Creativity	20	40
Precision	20	20
Safe presentation	20	20

The scores are given after the flight for all five criteria. It is important, that the scores for each criterion reflect the entire flight, not only some details of the flight.

**5G.8.1 DIFFICULTY**

This criterion evaluates the level of difficulty of the freestyle flight. It is important, that the entire flight is to be judged, not only some highlights. So the score reflects the average level of difficulty. The K-factors of the set manoeuvres may give some reference values for the difficulty, but during the calibration flights and by watching practice flights the judge should get a clear impression of the range of difficulties of possible manoeuvres. Risky manoeuvres should never be mistaken as difficult manoeuvres. Risky manoeuvres must not lead to higher scores for difficulty, but result in a downgrade for safety.

**5G.8.2 HARMONY**

The combination of the manoeuvres, smooth or flowing transitions between them are the main factors for this criterion. Also the manoeuvres size and dynamic in relation to the model aircrafts performance is of influence. The pace is not of influence here, harmony can be as well demonstrated in dynamic as in gentle sequences.

In Music flights also the harmony between the music and the presentation comes to influence here.

**5G.8.3 CREATIVITY**

New combinations or new manoeuvres at all will lead to high scores here. Also dynamic and diversified sequences are positive. There also should be a variety of different tempi in the presentation. Sequences without manoeuvres or repetitions will lead to downgrades.

In Music flights the transformation of musical accents into the performance is of great importance here.

cont/...

**5G.8.4 PRECISION**

Precision and recognition of manoeuvres and sequences are evaluated here. The criteria cannot be as strict as for the set manoeuvres as they have to meet an entire flight, but the principles stay the same.

**5G.8.5 SAFE PRESENTATION**

In addition to the safety rules during the flight(s) (5F.10), the impression of the presentation related to safety is the guide here. If a pilot does not exceed the limit of his skills or flies unsafe in any way (eg too close to himself) a high score can be given here. Flying low (within the rules) by itself is not a reason for downgrade.

**5G.8.6 EVALUATION OF THE LEVEL OF DIFFICULTY FOR FREESTYLE SCHEDULE**

The following table gives reference values for the estimation of the level of difficulty for both schedules, unlimited and music freestyle.

Score	Manoeuvres (examples)
6	Immelmann, short inverted passages, loop, loop with full pirouette on top, roll, turn, 540° turn, pirouettes, autorotation
11	½ Cuban eight, travelling pirouettes, long inverted passages, straight backwards flight, outside loop, vertical rolls, nose-in circle, flips
17	Inverted Immelmann, inverted hovering on eyelevel, circle backwards, loop with half pirouette on top, loop backwards, flip sideways, Cuban eight, flips with hovering stops
22	Horizontal eight backwards, loop sideways, backwards roll, vertical backwards roll, turn with hesitations and/or changes of turning direction, rolling stall turn, autorotation with 180 degree turn, death spiral, autorotation backwards
28	½ Cuban eight backwards, straight inverted backwards flight, stationary inverted nose-in hovering, pirouetting circle, 4-point roll, inverted nose-in circle
34	Inverted circle backwards, outside loop backwards, ½ Cuban eight inverted, turn backwards, knife edge pirouette, inverted speed circle
39	inverted pirouette, ½ Cuban eight sideways, travelling inverted pirouettes, inverted horizontal eight backwards, inverted backwards turn, 4-point roll backwards, rolling circle
45	Loop with flips, nose-in flips sideways, sideward flight with flips, inverted pirouetting circle, stationary tic-toc, funnel, inverted autorotation
49	½ backward Cuban eight inverted, Cuban eight backwards, inverted loop sideways, pirouetting flips
53	Combination of loops with changing direction and/or orientation, inverted funnel, snake, inverted autorotation backwards, inverted speed circle backwards
57	Pirouetting loop, 4-point tic-toc, rolling horizontal eight, rolling circle backwards, circle with flips, Cuban eight sideways, pirouetting autorotation
60	Inverted funnel eight, pirouetting outside loop, rolling circle with reversal, rolling horizontal eight backwards, autorotation with inverted pirouettes
64	Inverted Cuban eight sideways, rolling loop, circle or loop with pirouetting flips, tic-toc circle, rolling autorotation
68	Pirouetting tic-toc, rolling loop backwards, circle or eight with flips in varying directions, pirouetting funnel, inverted Cuban eight backwards
72	Rolling snake, tic-toc with rolls or flips, 4- or more point tic-toc, inverted pirouetting funnel, pirouetting globe, autorotation with pirouetting flips
76	Big Ben, inverted pirouetting globe, pirouetting snake, pirouetting flip with reversal
80	Pirouetting manoeuvres with reversal (loop, globe, funnel, snake tic-toc), autorotation with pirouetting flips and rolls

---oOo---